



HARDI ISO NOZZLES

Nozzle product guide

HARDI nozzle supremacy

Precise, dependable and accountable

HARDI has produced sprayers since 1957 - meeting the needs of all farmers and crops worldwide - a key goal that has demanded the world's best nozzles.

Today the same basic HARDI philosophy promotes the efficient, effective and responsible plant care that ensures quality food production.

The nozzle can dominate the sprayer performance. All of the sprayer components are important for safe and effective use, but it is the nozzle that can have the major influence on the performance of the crop protection product that it will apply.

The nozzle controls:

- The throughput [and therefore the dose]
- Quality of distribution
- Drop spectrum and coverage
- Distribution over the target
- Drop retention or reflection
- The degree of drift and downwind fall-out

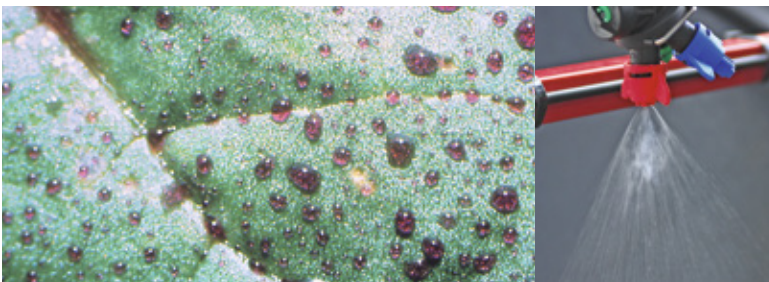

All these functions are considered by HARDI to ensure that the spray liquid is deposited exactly where it is needed, in its most effective form, and is not wasted.

HARDI has combined both design and material selection to produce a range of nozzles that suit the broad demands of both crops and the vast array of agrochemical products available today. This has been the basis for HARDI's worldwide success.

Close co-operation between farmers, advisers, chemical companies, independent and regulatory bodies with HARDI's agronomists has been the backbone of this continuing success.



Quality in production ensures optimal field performance.

HARDI's modern production facilities and technical abilities have resulted in the superior precision and durability of HARDI nozzles.

Quality control includes not just laboratory measurements but the use of HARDI nozzles in the field under commercial conditions. Every drop of spray needs to be both accounted for - and documented - in order to ensure the quality of food delivered onto the dining table, and it meets the demands of the public today.

HARDI quality nozzles meet these increasing demands with world leading research and development.

The application of plant protection products to crops involves issues now, which go beyond traditional considerations such as economy and efficiency. Now nozzle choice and performance also relate to broad issues of drift such as airborne losses, downwind fall-out and deposits on non-target surfaces within the treated area itself. All of these issues need to be carefully considered.

HARDI is world leading in the understanding of concept of spray accountability and it is this knowledge that underpins its world leadership in today's spraying. Today, HARDI has developed the world's largest ISO nozzle programmes for agriculture, horticulture [including most vegetables], viticulture as well as many more specialist needs. This nozzle guide will help you select the best nozzle for your needs, consider environmental aspects, and help you calibrate it for optimal use to ensure that you meet all of today's needs when using crop protection products.

Nozzle technology

Fundamental research with nozzles by “HARDI agro-scientists” is conducted in their own dedicated laboratories and those of independent Research Centres at many key institutions throughout the world. Sites where field research is conducted are very diverse - ranging from the temperate conditions of Northern Europe to the tropical crops of Australia.

Instrumentation used in HARDI's laboratories is at the leading edge in drop size analysis studies. It is this broad - but intensive approach - which, when combined with state-of-the-art manufacturing techniques and computerized quality control programmes, guarantees that HARDI nozzles will meet the demands of better crop protection.

Measuring droplet sizes

The droplet spectrum is characterized by the average droplet size based on volume (VMD) and the range that indicates the uniformity of the atomization. A laser Phase

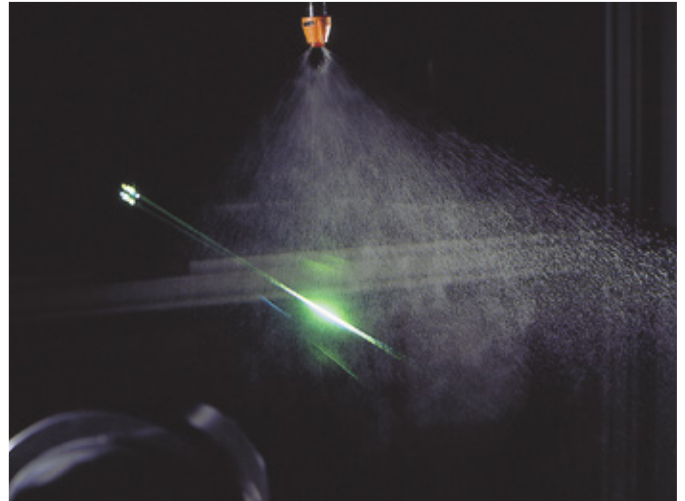

Doppler Particle Analyser (Aerometrics, PDPA) supplies this information instantaneously and is used to constantly monitor in our laboratory the spray quality of our nozzles.

HARDI Flat fan nozzles

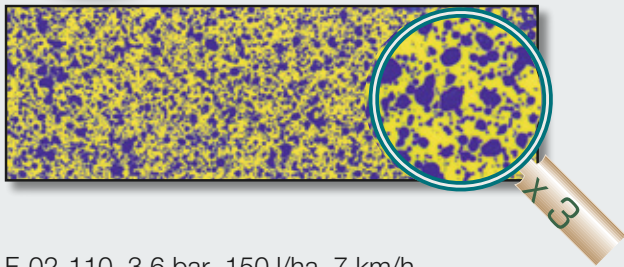

F-02-110 3.6 bar 150 l/ha 7 km/h

HARDI LD LowDrift nozzles

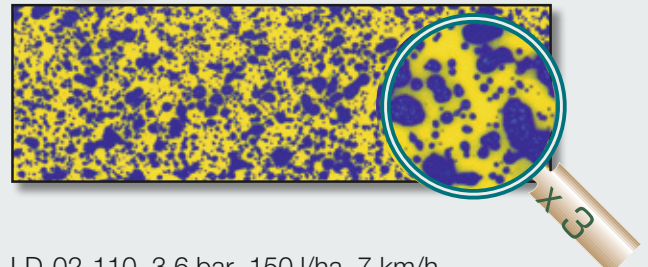

LD-02-110 3.6 bar 150 l/ha 7 km/h

HARDI MINIDRIFT nozzles

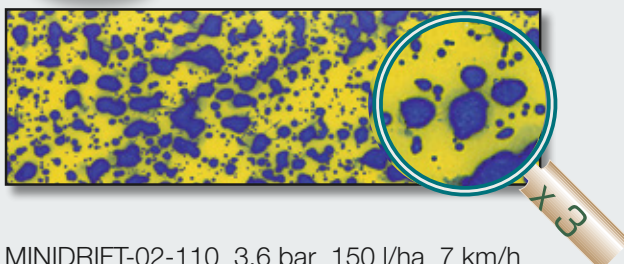

MINIDRIFT-02-110 3.6 bar 150 l/ha 7 km/h

HARDI INJET nozzles

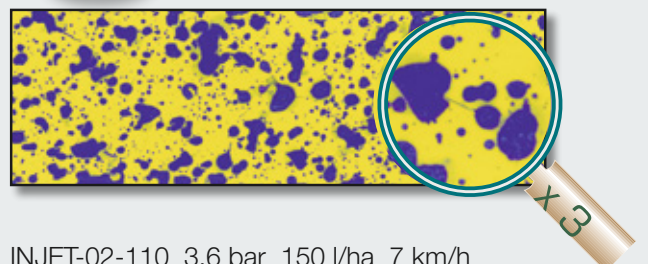

INJET-02-110 3.6 bar 150 l/ha 7 km/h

Nozzle technology

Nozzle development

Changes in cropping practices, regulatory restraints and the introduction of new agrochemicals are just some of the forces that ensure new nozzle developments, which have and will continue to take place at HARDI. This activity closely involves our agronomists, engineers and specialist tool makers. Farmer's needs are recognized and met with HARDI nozzles designed to provide the precision he demands today.

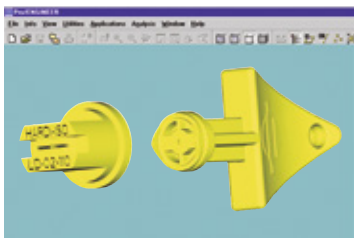

Quality control

Samples of all HARDI nozzles are constantly monitored by Quality Control - using devices such as this state-of-the-art nozzle distribution table.



Wind Tunnel Studies

Airborne drift and downwind fallout are tested and documented in the controlled conditions of a wind tunnel for all HARDI nozzles. This leads to approvals as drift reducing equipment for buffer zones in many countries.

Together with field research this has given the HARDI nozzle range approvals in the UK, Holland and Germany to be used closer to waterways than previously allowed with traditional nozzles.

High Speed Video

Modern high-speed video techniques are used to investigate the droplets' behaviour on their way to the target and when impacting on a leaf. These tests are done with clean water and with actives to simulate in-field spraying.

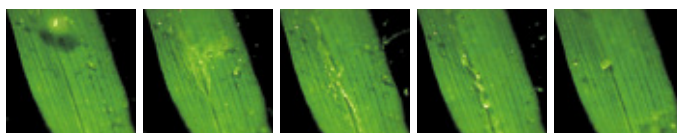

High Quality Materials

HARDI nozzles are produced from high quality SYNTAL plastic that ensures both precision and durability. Where highly abrasive compounds are to be sprayed, the selection of HARDI CERAMIC nozzles will maintain this same level of superior durability.

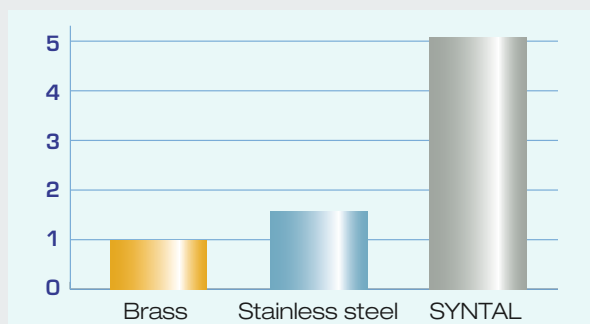

Durability relative to brass flat spray nozzle at the manufacturer's recommended pressure

(Kim Sintorn, Swedish University).

Deposit tests

In UK fluorescent dye is used to test the exact amount of liquid that stays on the leaf after spraying. This is the key factor for the biological efficacy of the plant protection products.

Efficacy trials

Specialist field equipment is used at the Danish Weed Research Institute to test the efficacy of herbicide performance when using HARDI nozzles.

Choosing nozzles

A nozzle for every spray job

Choice of nozzle type and size may have to balance the need to ensure optimal biological effect with a consideration for wind drift, sprayer capacity – that influences field work rates – as well as forward speed.

Small droplets from STANDARD Flat Fan nozzles may offer an unsurpassed liquid distribution and an effective coverage of the target surface. HARDI TWIN sprayers can safely use these small standard nozzles even when weather conditions are not optimal.

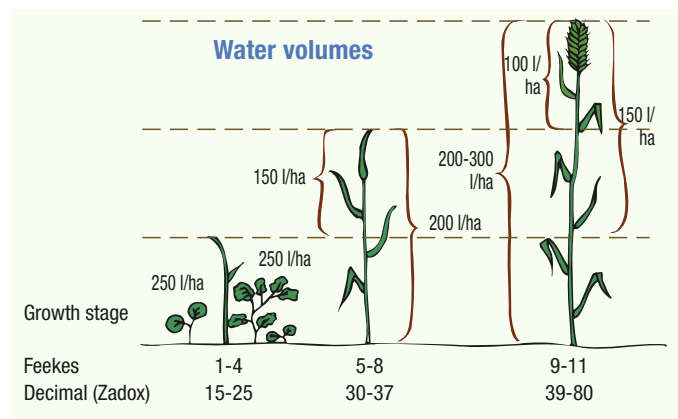

The reduced number of very small droplets produced by LowDrift nozzles makes them less sensitive to wind. Therefore, they can be used on conventional sprayers under sub-optimal conditions. In particular, they are popular used when spraying lower water volumes. MINIDRIFT and INJET nozzles mix air with the spray liquid to coarsen the atomisation. Drift is substantially reduced with these nozzles so that field delays – through too high wind speeds – are minimised and timing is improved. The biological advantage gained through this better field timing may mask the use of coarser sprays. Their use has become critical to conventional spraying practice which has to try and meet both environmental needs without risking the effectiveness of the product to be applied.

Water volume rate has a big influence

Your working capacity will largely depend on the water volume rate. Why? Low volume rates mean that less filling time and transport are required. In fact a volume rate reduction of 25% increases your capacity by more than 10%. A big difference even in the short term! You do, however, need to pick the right nozzle and speed for the job. Lower spray pressure alone will mean that both coverage and deposit are reduced. Note that the application rate of a nozzle should be approximately +/-40% of the medium flow at 3.25 bar.

Classification category	Symbol	Colour code	Approximate VMD
Very fine	VF		<140
Fine	F		140-210
Medium	M		210-320
Coarse	C		320-380
Very coarse	VC		380-460
Extremely coarse	XC		460-620
Ultra coarse	UC		>620

What about droplet size?

Droplet size is important, and your need will differ according to conditions and type of crop. HARDI nozzles follow BCPC/ASAE specifications with regard to droplet size classification. There are 7 size classifications but for most types of farming only “fine”, “medium”, “coarse” and “very coarse” are relevant. The challenge is that no nozzle will give you all spraying options and that is why you sometimes have to compromise.

025-Lilac	1.5	0.71	M	141	121	106	85	71	57	42	34
	2.0	0.82	M	163	140	122	98	82	65	49	39
	2.5	0.91	M	183	156	137	110	91	73	55	44
	3.0	1.00	M	200	171	150	120	100	80	60	48
	4.0	1.15	F	231	198	173	139	115	92	69	55
	5.0	1.29	F	258	221	194	155	129	103	77	62
		SYNTAL-CT 371950 (12 pcs. 750626)				SYNTAL-S 371946 (12 pcs. 750628)					

The VMD data is belonging to the used measuring equipment. So the VMD data is only an estimate. The borders between the different categories are defined by a certain nozzle which is standardized in the ISO 25358. HARDI will only give the categories as the VMD as a single measurement is not useful for farmers as a decision tool. On the nozzle flow tables in this product guide is a separate column to indicate the spray quality.

Make sure you have drift reduction nozzles

The new directive from EU states that a sprayer must be equipped with drift reduction nozzles. So if you have not already considered a MINIDRIFT nozzle, maybe now is the time. Standard equipment on a sprayer will soon be required anyway. Drift reduction nozzles work with very coarse droplets; this is the only way to reach a high drift reduction level.

Choosing nozzles

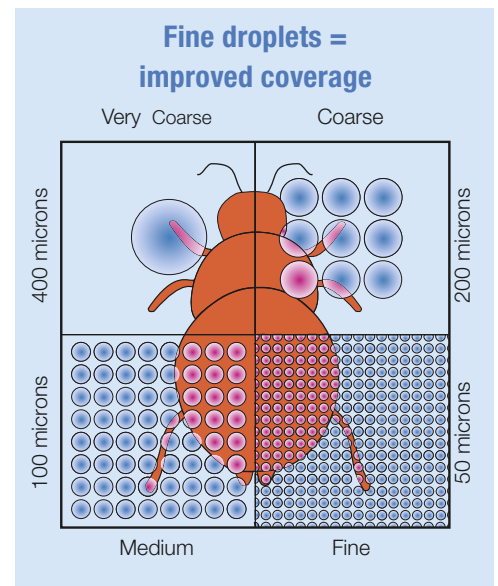
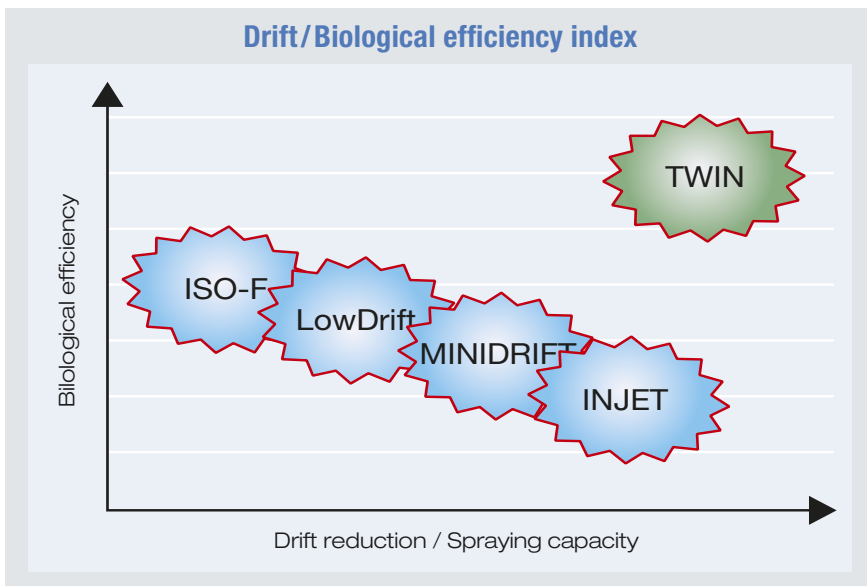

Choosing nozzles

The tables on the next page can be used when choosing the right nozzle for a spray job. Important precondition for the tables:

- Always follow label recommendation for spray quality and volume rate – if nothing is stated, the tables on the next page can be used as a guideline.
- To minimise wind drift and maintain even liquid distribution, spraying pressure between 1.5 and 2.5 bar is recommended (INJET: 3 to 5 bar). Higher pressures with TWIN air assistance are also acceptable.
- Spraying against grass weeds or on other vertical targets – it is important to use a relative fine spray for a good coverage.
- Small dicot weeds need good coverage either through fine droplets or – if using a coarser spray – by compensating with a higher volume rate.

- Contact action mode needs finer droplets.
- Use medium sized droplets for chemicals that are transported in the plants
- For large dicot weeds – coarse atomisation can be used.
- Fungicide treatments are often less sensitive to spray quality; medium drops can be recommended. Remember that the volume rate must be adjusted to crop density and needs for penetration to more basal parts.
- Generally the water rate for conventional spraying should not be less than 150 l/ha and for TWIN not less than 80 – 100 l/ha for optimum efficacy at lower chemical doses.
- When mixing products or using products with more than one mode of action, adjust to the most demanding component of that product mix.

Spray quality and capacity for HARDI ISO 110° flat fan nozzles

HARDI ISO F-110
Standard flat fan nozzles

ISO size/colour	bar					
	1.5	2.0	2.5	3.0	4.0	5.0
0075-Pink	0.21	0.24	0.27	0.30	0.35	0.39
01-Orange	0.28	0.33	0.37	0.40	0.46	0.52
015-Green	0.42	0.49	0.55	0.60	0.69	0.77
02-Yellow	0.57	0.65	0.73	0.80	0.92	1.03
025-Lilac	0.71	0.82	0.91	1.00	1.15	1.29
03-Blue	0.85	0.98	1.10	1.20	1.39	1.55
04-Red	1.13	1.31	1.46	1.60	1.85	2.07
05-Brown	1.41	1.63	1.83	2.00	2.31	2.58
06-Grey	1.70	1.96	2.19	2.40	2.77	3.10
08-White	2.26	2.61	2.92	3.20	3.70	4.13
10-Light blue	2.83	3.27	3.65	4.00	4.62	5.16

HARDI ISO LD-110
LowDrift nozzles

ISO size/colour	bar					
	1.5	2.0	2.5	3.0	4.0	5.0
01-Orange	0.28	0.33	0.37	0.40	0.46	0.52
015-Green	0.42	0.49	0.55	0.60	0.69	0.77
02-Yellow	0.57	0.65	0.73	0.80	0.92	1.03
025-Lilac	0.71	0.82	0.91	1.00	1.15	1.29
03-Blue	0.85	0.98	1.10	1.20	1.39	1.55
04-Red	1.13	1.31	1.46	1.60	1.85	2.07
05-Brown	1.41	1.63	1.83	2.00	2.31	2.58

HARDI ISO MINIDRIFT
Air inclusion nozzles

ISO size/colour	bar					
	1.5	2.0	2.5	3.0	4.0	5.0
015-Green	0.42	0.49	0.55	0.60	0.69	0.77
02-Yellow	0.57	0.65	0.73	0.80	0.92	1.03
025-Lilac	0.71	0.82	0.91	1.00	1.15	1.29
03-Blue	0.85	0.98	1.10	1.20	1.39	1.55
04-Red	1.13	1.31	1.46	1.60	1.85	2.07
05-Brown	1.41	1.63	1.83	2.00	2.31	2.58

HARDI ISO INJET
Air inclusion nozzles

ISO size/colour	bar					
	3.0	4.0	5.0	6.0	7.0	8.0
01-Orange	0.40	0.46	0.52	0.57	0.61	0.65
015-Green	0.60	0.69	0.77	0.85	0.92	0.98
02-Yellow	0.80	0.92	1.03	1.13	1.22	1.31
025-Lilac	1.00	1.15	1.29	1.41	1.53	1.63
03-Blue	1.20	1.39	1.55	1.70	1.83	1.96
04-Red	1.60	1.85	2.07	2.26	2.44	2.61
05-Brown	2.00	2.31	2.58	2.83	3.06	3.27
06-Grey	2.40	2.77	3.10	3.39	3.67	3.92
08-White	3.20	3.70	4.13	4.53	4.89	5.23

Spray quality:



Fine	Coarse
Medium	Very coarse



Choosing nozzles

Conventional sprayers																	
	Normal spraying conditions - forward speed 6-8 km/h						Normal spraying conditions - forward speed 8-10 km/h						Windy, but cannot postpone - forward speed 5-6 km/h				
	Standard ISO F-110		LowDrift ISO LD-110		MD/ INJET		Standard ISO F-110		LowDrift ISO LD-110		MD/ INJET		Standard ISO F-110		LowDrift ISO LD-110		MD/ INJET
Spray quality	F	M	C	M	C	VC	F	M	C	M	C	VC	M	C	M	C	VC
Herbicides - soil applied		100-200 l/ha	200 l/ha	100-200 l/ha	100-200 l/ha	100-200 l/ha											
- grass weeds		150-200 l/ha		150-200 l/ha													
- broadleaf weeds up to 2 cm across		150-200 l/ha		150-200 l/ha					200-250 l/ha		175-250 l/ha					175-250 l/ha	
- broadleaf weeds more than 2 cm across		150-200 l/ha		150-200 l/ha					200-250 l/ha		150-250 l/ha	200-250 l/ha				175-200 l/ha	200-250 l/ha
- Glyphosate		100-150 l/ha		100-150 l/ha							150-200 l/ha	150-200 l/ha				175-200 l/ha	150-200 l/ha
Fungicides - contact		150-300 l/ha		150-300 l/ha													
- systemic		150-300 l/ha		150-300 l/ha					200-300 l/ha		175-250 l/ha					175-300 l/ha	
Insecticides - contact		150-250 l/ha		150-250 l/ha													
- systemic		100-200 l/ha		100-200 l/ha					200-250 l/ha		175-250 l/ha					175-250 l/ha	

TWIN air assisted sprayers																	
	Normal spraying conditions - forward speed 8-10 km/h						Normal spraying conditions - forward speed 12-15 km/h						Windy spraying conditions - forward speed 10-12 km/h				
	Standard ISO F-110		LowDrift ISO LD-110		MD/ INJET		Standard ISO F-110		LowDrift ISO LD-110		MD/ INJET		Standard ISO F-110		LowDrift ISO LD-110		MD/ INJET
Spray quality	F	M	C	M	C	VC	F	M	C	M	C	VC	M	C	M	C	VC
Herbicides - soil applied		100-200 l/ha	200 l/ha	100-150 l/ha	100-200 l/ha			100-150 l/ha	100-250 l/ha		100-200 l/ha	100-200 l/ha		150-200 l/ha		100-200 l/ha	
- grass weeds		100-150 l/ha	100-200 l/ha		150-200 l/ha			150-200 l/ha		150-200 l/ha						150-200 l/ha	
- broadleaf weeds up to 2 cm across		80-150 l/ha	100-200 l/ha		150-200 l/ha			150-200 l/ha		150-200 l/ha						150-200 l/ha	
- broadleaf weeds more than 2 cm across		80-150 l/ha	100-200 l/ha		150-200 l/ha			150-200 l/ha		150-250 l/ha				175-250 l/ha	150-200 l/ha	150-200 l/ha	200-250 l/ha
- Glyphosate		80-120 l/ha	100-150 l/ha		100-150 l/ha			100-150 l/ha		100-150 l/ha	150-200 l/ha			100-150 l/ha	150-200 l/ha	150-200 l/ha	150-200 l/ha
Fungicides - contact		100-200 l/ha	100-200 l/ha		150-200 l/ha			150-200 l/ha		150-200 l/ha						150-200 l/ha	
- systemic		80-120 l/ha	100-200 l/ha		150-200 l/ha			150-200 l/ha		150-200 l/ha						150-200 l/ha	
Insecticides - contact		100-200 l/ha	100-200 l/ha		150-200 l/ha			150-200 l/ha		150-200 l/ha						150-200 l/ha	
- systemic		80-200 l/ha	100-200 l/ha		100-200 l/ha			100-200 l/ha		100-200 l/ha						100-200 l/ha	

-  Best choice
-  Useful alternative
-  Under optimum spraying conditions when fine atomisation can be used with no drift hazard

INJET The very coarse atomisation from INJET nozzles often requires higher water volume rates to compensate for poor coverage

Spray quality:

Fine	Coarse
Medium	Very coarse



Calibration of field crop sprayers

Precise, safe, applications in the field demand that the sprayer is effectively calibrated. Calibration must always be done with clean water and before the use of any crop protection product. Follow these three steps to calibrate your sprayer:

1 Check driving speed

Half-fill the spray tank with water.

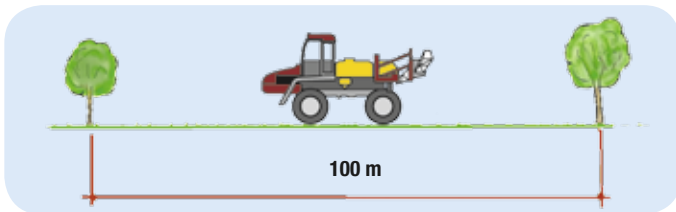

Mark out 100 m – note time to drive the distance.

Example

If it takes 50 seconds to drive 100 metres, the spraying speed is 7.2 km/hour.

Driving speed formula

$$\frac{\text{distance driven (m)} \times 3.6}{\text{time (sec.)}} = \text{km/h}$$

3 Check nozzle output

- If actual output is not equal to desired output: Readjust pressure. (alternatively, change nozzle or driving speed)
- If output has increased more than 10% from table value, change all nozzles.



2 Select volume rate, nozzle and pressure

For easy selection of nozzles and pressure, use the HARDI calibration disk (order No. 285802).

Example

Volume rate	250 l/ha	Pressure	2.90 bar
Driving speed	7.5 km/h	Nozzle flow	1.56 l/min
Nozzle	ISO F-04-110		

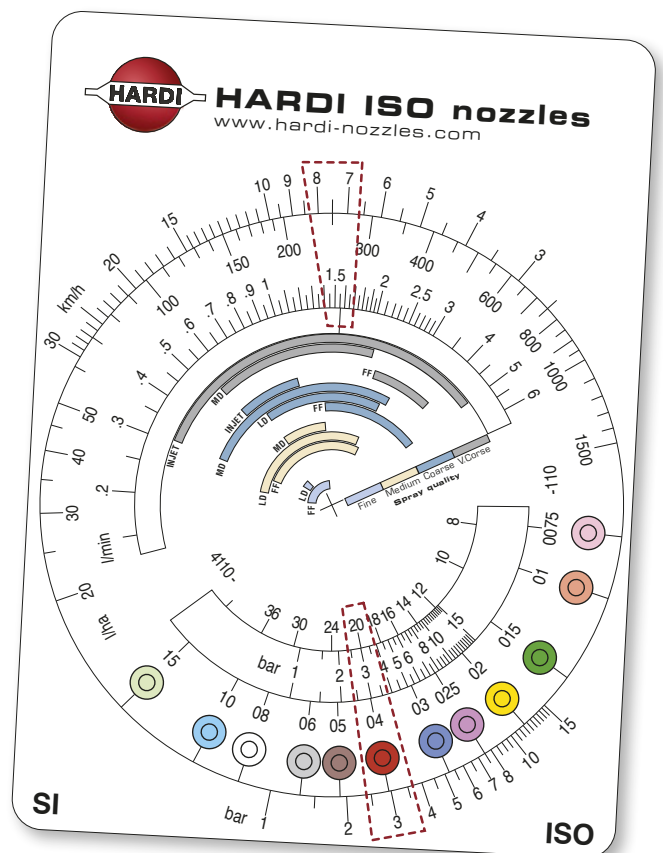

Calibration formulas

When calibrating, it is the perfect time to check the spray distribution across your boom. Here you have clean water in the whole system and a great opportunity to inspect your sprayer for any leaks, blockages, etc.

Speed check

$$\frac{\text{distance (m)} \times 3.6}{\text{Time (s)}} = \text{km/h}$$

Nozzle output

$$\frac{\text{nozzle spacing (m)} \times \text{l/ha} \times \text{km/h}}{600} = \text{l/min (per nozzle)}$$

Pressure adjustment

$$\left(\frac{\text{new output (l/min)}}{\text{known output (l/min)}} \right)^2 \times \text{known pressure (bar)} = \text{new pressure (bar)}$$

Application volume

$$\frac{600 \times \text{l/min (per nozzle)}}{\text{nozzle spacing (m)} \times \text{km/h}} = \text{l/ha}$$

Calibration of field crop sprayers

Cleaning of nozzles

An even distribution across your boom is critical to the performance of the product you are applying. Dirty and/or blocked nozzles are the most frequently reported

problem affecting distribution. Cleaning nozzles is best done using water and a soft brush such as a toothbrush. Never use tools like screwdrivers or nails - they will certainly damage the nozzle and its ability to evenly distribute the sprayed liquid.



A soft brush for nozzle cleaning is included as a part of the HARDI calibration set (818492).



Liquid fertilizer

Liquid fertilizers may be of a higher liquid density than water and almost all normal spray solutions. The density correction table below states the increased pressure that will be needed to reach the required output with such liquids.

Example

The nozzle has an output of 2.03 l/min at 3 bar. If the density of the liquid fertilizer is 1.2 g/cm³ you have to multiply the calibration pressure – found when checking the nozzle flow with water – with the density factor. This gives an adjusted pressure of 3.6 bar. The value can be found in the table at 3 bar (calibrated pressure) and a density of 1.2 g/cm³.

bar	Density (g/cm ³)				
	1.10	1.15	1.20	1.30	1.40
	Adjusted pressure (bar)				
1.0	1.1	1.2	1.2	1.3	1.4
1.5	1.7	1.7	1.8	2.0	2.1
2.0	2.2	2.3	2.4	2.6	2.8
2.5	2.8	2.9	3.0	3.3	3.5
3.0	3.3	3.5	3.6	3.9	4.2

When did you last check the output from your nozzles?

1. After every week of spraying, check minimum 2 nozzles per boom section
2. If the flow from one or more of these nozzles has increased more than 15% compared to a new nozzle, change all nozzles.

Water sensitive paper

An important tool to check the spray quality and deposition in the field. Buy it at your HARDI dealer.

25 x 75 mm
50 pcs. no: 893211



Nozzle flow

If your water volume rate and spraying speed are known, use this table to identify the flow rate that will be required by the nozzle. The nozzle flow rate [litres/minute] selected from this table can be used together with the nozzle tables on the following pages to identify a suitable nozzle.

km/h	l/ha															
	25	50	75	100	125	150	175	200	250	300	350	400	450	500	550	600
3				0.25	0.31	0.38	0.44	0.50	0.63	0.75	0.88	1.00	1.13	1.25	1.38	1.50
4			0.25	0.33	0.42	0.50	0.58	0.67	0.83	1.00	1.17	1.33	1.50	1.67	1.83	2.00
5		0.21	0.31	0.42	0.52	0.63	0.73	0.83	1.04	1.25	1.46	1.67	1.88	2.08	2.29	2.50
6		0.25	0.38	0.50	0.63	0.75	0.88	1.00	1.25	1.50	1.75	2.00	2.25	2.50	2.75	3.00
7		0.29	0.44	0.58	0.73	0.88	1.02	1.17	1.46	1.75	2.04	2.33	2.63	2.92	3.21	3.50
8		0.33	0.50	0.67	0.83	1.00	1.17	1.33	1.67	2.00	2.33	2.67	3.00	3.33	3.67	4.00
9		0.38	0.56	0.75	0.94	1.13	1.31	1.50	1.88	2.25	2.63	3.00	3.38	3.75	4.13	4.50
10	0.21	0.42	0.63	0.83	1.04	1.25	1.46	1.67	2.08	2.50	2.92	3.33	3.75	4.17	4.58	5.00
12	0.25	0.50	0.75	1.00	1.25	1.50	1.75	2.00	2.50	3.00	3.50	4.00	4.50	5.00		
15	0.31	0.63	0.94	1.25	1.56	1.88	2.19	2.50	3.13	3.75	4.38	5.00				
20	0.42	0.83	1.25	1.67	2.08	2.50	2.92	3.33	4.17	5.00						



HARDI ISO F-110 - Standard flat fan nozzles



All-round flat fan nozzle. Recommended for all types of pesticide application where optimum coverage is demanded. This nozzle will give you excellent and uniform liquid distribution at boom heights from 35 to 70 cm (50 cm recommended to take care of uneven terrain or boom movements).

- ISO – flow, colour and outer dimensions
- Working pressure – 1.5 to 5 bar
- Recommended for TWIN sprayers
- SYNTAL – precision moulded thermoplastic
- CERAMIC – extremely high durability
- COLOR TIPS – for safe and easy handling

bar	l/min	Spray quality	l/ha at km/h						
			6	7	8	10	12	15	20

0075-Pink	1.5	0.21	F	42	36	32	25	21	17	13	10
	2.0	0.24	F	49	42	37	29	24	20	15	12
	2.5	0.27	F	55	47	41	33	27	22	16	13
	3.0	0.30	F	60	51	45	36	30	24	18	14
	4.0	0.35	F	69	59	52	42	35	28	21	17
	5.0	0.39	F	77	66	58	46	39	31	23	19
				SYNTAL-CT	371964 (12 pcs. 755634)			SYNTAL-S	371963 (12 pcs. 755635)		

01-Orange	1.5	0.28	F	57	48	42	34	28	23	17	14
	2.0	0.33 <td>F</td> <td>65</td> <td>56</td> <td>49</td> <td>39</td> <td>33</td> <td>26</td> <td>20</td> <td>16</td>	F	65	56	49	39	33	26	20	16
	2.5	0.37 <td>F</td> <td>73</td> <td>63</td> <td>55</td> <td>44</td> <td>37</td> <td>29</td> <td>22</td> <td>18</td>	F	73	63	55	44	37	29	22	18
	3.0	0.40 <td>F</td> <td>80</td> <td>69</td> <td>60</td> <td>48</td> <td>40</td> <td>32</td> <td>24</td> <td>19</td>	F	80	69	60	48	40	32	24	19
	4.0	0.46 <td>F</td> <td>92</td> <td>79</td> <td>69</td> <td>55</td> <td>46</td> <td>37</td> <td>28</td> <td>22</td>	F	92	79	69	55	46	37	28	22
	5.0	0.52 <td>F</td> <td>103</td> <td>89</td> <td>77</td> <td>62</td> <td>52</td> <td>41</td> <td>31</td> <td>25</td>	F	103	89	77	62	52	41	31	25
				SYNTAL-CT	371764 (12 pcs. 755627)			SYNTAL-S	371706 (12 pcs. 755643)		

015-Green	1.5	0.42	M	85	73	64	51	42	34	25	20
	2.0	0.49 <td>F</td> <td>98</td> <td>84</td> <td>73</td> <td>59</td> <td>49</td> <td>39</td> <td>29</td> <td>24</td>	F	98	84	73	59	49	39	29	24
	2.5	0.55 <td>F</td> <td>110</td> <td>94</td> <td>82</td> <td>66</td> <td>55</td> <td>44</td> <td>33</td> <td>26</td>	F	110	94	82	66	55	44	33	26
	3.0	0.60 <td>F</td> <td>120</td> <td>103</td> <td>90</td> <td>72</td> <td>60</td> <td>48</td> <td>36</td> <td>29</td>	F	120	103	90	72	60	48	36	29
	4.0	0.69 <td>F</td> <td>139</td> <td>119</td> <td>104</td> <td>83</td> <td>69</td> <td>55</td> <td>42</td> <td>33</td>	F	139	119	104	83	69	55	42	33
	5.0	0.77 <td>F</td> <td>155</td> <td>133</td> <td>116</td> <td>93</td> <td>77</td> <td>62</td> <td>46</td> <td>37</td>	F	155	133	116	93	77	62	46	37
				SYNTAL-CT	371765 (12 pcs. 755628)			SYNTAL-S	371707 (12 pcs. 755646)		
			CERAMIC-CT	371772 (12 pcs. 755635)			CERAMIC-S	371738 (12 pcs. 755667)			

02-Yellow	1.5	0.57	M	113	97	85	68	57	45	34	27
	2.0	0.65 <th>M</th> <td>131</td> <td>112</td> <td>98</td> <td>78</td> <td>65</td> <td>52</td> <td>39</td> <td>31</td>	M	131	112	98	78	65	52	39	31
	2.5	0.73 <td>F</td> <td>146</td> <td>125</td> <td>110</td> <td>88</td> <td>73</td> <td>58</td> <td>44</td> <td>35</td>	F	146	125	110	88	73	58	44	35
	3.0	0.80 <td>F</td> <td>160</td> <td>137</td> <td>120</td> <td>96</td> <td>80</td> <td>64</td> <td>48</td> <td>38</td>	F	160	137	120	96	80	64	48	38
	4.0	0.92 <td>F</td> <td>185</td> <td>158</td> <td>139</td> <td>111</td> <td>92</td> <td>74</td> <td>55</td> <td>44</td>	F	185	158	139	111	92	74	55	44
	5.0	1.03 <td>F</td> <td>207</td> <td>177</td> <td>155</td> <td>124</td> <td>103</td> <td>83</td> <td>62</td> <td>50</td>	F	207	177	155	124	103	83	62	50
				SYNTAL-CT	371766 (12 pcs. 755629)			SYNTAL-S	371708 (12 pcs. 755649)		
			CERAMIC-CT	371773 (12 pcs. 755636)			CERAMIC-S	371739 (12 pcs. 755670)			

025-Lilac	1.5	0.71	M	141	121	106	85	71	57	42	34
	2.0	0.82 <th>M</th> <td>163</td> <td>140</td> <td>122</td> <td>98</td> <td>82</td> <td>65</td> <td>49</td> <td>39</td>	M	163	140	122	98	82	65	49	39
	2.5	0.91 <th>M</th> <td>183</td> <td>156</td> <td>137</td> <td>110</td> <td>91</td> <td>73</td> <td>55</td> <td>44</td>	M	183	156	137	110	91	73	55	44
	3.0	1.00 <th>M</th> <td>200</td> <td>171</td> <td>150</td> <td>120</td> <td>100</td> <td>80</td> <td>60</td> <td>48</td>	M	200	171	150	120	100	80	60	48
	4.0	1.15 <td>F</td> <td>231</td> <td>198</td> <td>173</td> <td>139</td> <td>115</td> <td>92</td> <td>69</td> <td>55</td>	F	231	198	173	139	115	92	69	55
	5.0	1.29 <td>F</td> <td>258</td> <td>221</td> <td>194</td> <td>155</td> <td>129</td> <td>103</td> <td>77</td> <td>62</td>	F	258	221	194	155	129	103	77	62
				SYNTAL-CT	371950 (12 pcs. 755626)			SYNTAL-S	371946 (12 pcs. 755628)		

= Spray quality:
 Fine (F), Medium (M), Coarse (C), Very Coarse (VC).

bar	l/min	Spray quality	l/ha at km/h						
			6	7	8	10	12	15	20

03-Blue	1.5	0.85	M	170	145	127	102	85	68	51	41
	2.0	0.98 <th>M</th> <td>196</td> <td>168</td> <td>147</td> <td>118</td> <td>98</td> <td>78</td> <td>59</td> <td>47</td>	M	196	168	147	118	98	78	59	47
	2.5	1.10 <th>M</th> <td>219</td> <td>188</td> <td>164</td> <td>131</td> <td>110</td> <td>88</td> <td>66</td> <td>53</td>	M	219	188	164	131	110	88	66	53
	3.0	1.20 <th>M</th> <td>240</td> <td>206</td> <td>180</td> <td>144</td> <td>120</td> <td>96</td> <td>72</td> <td>58</td>	M	240	206	180	144	120	96	72	58
	4.0	1.39 <th>M</th> <td>277</td> <td>238</td> <td>208</td> <td>166</td> <td>139</td> <td>111</td> <td>83</td> <td>67</td>	M	277	238	208	166	139	111	83	67
	5.0	1.55 <th>M</th> <td>310</td> <td>266</td> <td>232</td> <td>186</td> <td>155</td> <td>124</td> <td>93</td> <td>74</td>	M	310	266	232	186	155	124	93	74
				SYNTAL-CT	371767 (12 pcs. 755630)			SYNTAL-S	371709 (12 pcs. 755652)		
			CERAMIC-CT	371774 (12 pcs. 755637)			CERAMIC-S	371740 (12 pcs. 755673)			

04-Red	1.5	1.13	M	226	194	170	136	113	91	68	54
	2.0	1.31 <th>M</th> <td>261</td> <td>224</td> <td>196</td> <td>157</td> <td>131</td> <td>105</td> <td>78</td> <td>63</td>	M	261	224	196	157	131	105	78	63
	2.5	1.46 <th>M</th> <td>292</td> <td>250</td> <td>219</td> <td>175</td> <td>146</td> <td>117</td> <td>88</td> <td>70</td>	M	292	250	219	175	146	117	88	70
	3.0	1.60 <th>M</th> <td>320</td> <td>274</td> <td>240</td> <td>192</td> <td>160</td> <td>128</td> <td>96</td> <td>77</td>	M	320	274	240	192	160	128	96	77
	4.0	1.85 <th>M</th> <td>370</td> <td>317</td> <td>277</td> <td>222</td> <td>185</td> <td>148</td> <td>111</td> <td>89</td>	M	370	317	277	222	185	148	111	89
	5.0	2.07 <th>M</th> <td>413</td> <td>354</td> <td>310</td> <td>248</td> <td>207</td> <td>165</td> <td>124</td> <td>99</td>	M	413	354	310	248	207	165	124	99
				SYNTAL-CT	371768 (12 pcs. 755631)			SYNTAL-S	371710 (12 pcs. 755655)		
			CERAMIC-CT	371775 (12 pcs. 755638)			CERAMIC-S	371741 (12 pcs. 755676)			

05-Brown	1.5	1.41	C	283	242	212	170	141	113	85	68
	2.0	1.63 <th>C</th> <td>327</td> <td>280</td> <td>245</td> <td>196</td> <td>163</td> <td>131</td> <td>98</td> <td>78</td>	C	327	280	245	196	163	131	98	78
	2.5	1.83 <th>M</th> <td>365</td> <td>313</td> <td>274</td> <td>219</td> <td>183</td> <td>146</td> <td>110</td> <td>88</td>	M	365	313	274	219	183	146	110	88
	3.0	2.00 <th>M</th> <td>400</td> <td>343</td> <td>300</td> <td>240</td> <td>200</td> <td>160</td> <td>120</td> <td>96</td>	M	400	343	300	240	200	160	120	96
	4.0	2.31 <th>M</th> <td>462</td> <td>396</td> <td>346</td> <td>277</td> <td>231</td> <td>185</td> <td>139</td> <td>111</td>	M	462	396	346	277	231	185	139	111
	5.0	2.58 <th>M</th> <td>516</td> <td>443</td> <td>387</td> <td>310</td> <td>258</td> <td>207</td> <td>155</td> <td>124</td>	M	516	443	387	310	258	207	155	124
				SYNTAL-CT	371769 (12 pcs. 755632)			SYNTAL-S	371711 (12 pcs. 755658)		
			CERAMIC-CT	371776 (12 pcs. 755639)			CERAMIC-S	371742 (12 pcs. 755679)			

06-Grey	1.5	1.70	C	339	291	255	204	170	136	102	81
	2.0	1.96 <th>C</th> <td>392</td> <td>336</td> <td>294</td> <td>235</td> <td>196</td> <td>157</td> <td>118</td> <td>94</td>	C	392	336	294	235	196	157	118	94
	2.5	2.19 <th>C</th> <td>438</td> <td>376</td> <td>329</td> <td>263</td> <td>219</td> <td>175</td> <td>131</td> <td>105</td>	C	438	376	329	263	219	175	131	105
	3.0	2.40 <th>C</th> <td>480</td> <td>411</td> <td>360</td> <td>288</td> <td>240</td> <td>192</td> <td>144</td> <td>115</td>	C	480	411	360	288	240	192	144	115
	4.0	2.77 <th>C</th> <td>554</td> <td>475</td> <td>416</td> <td>333</td> <td>277</td> <td>222</td> <td>166</td> <td>133</td>	C	554	475	416	333	277	222	166	133
	5.0	3.10 <th>C</th> <td>620</td> <td>531</td> <td>465</td> <td>372</td> <td>310</td> <td>248</td> <td>186</td> <td>149</td>	C	620	531	465	372	310	248	186	149
				SYNTAL-CT	371770 (12 pcs. 755633)			SYNTAL-S	371712 (12 pcs. 755661)		
			CERAMIC-CT	371777 (12 pcs. 755640)			CERAMIC-S	371743 (12 pcs. 755682)			

08-White	1.5	2.26	VC	453	388	339	272	226	181	136	109
	2.0	2.61 <th>C</th> <td>523</td> <td>448</td> <td>392</td> <td>314</td> <td>261</td> <td>209</td> <td>157</td> <td>125</td>	C	523	448	392	314	261	209	157	125
	2.5	2.92 <th>C</th> <td>584</td> <td>501</td> <td>438</td> <td>351</td> <td>292</td> <td>234</td> <td>175</td> <td>140</td>	C	584	501	438	351	292	234	175	140
	3.0	3.20 <th>C</th> <td>640</td> <td>549</td> <td>480</td> <td>384</td> <td>320</td> <td>256</td> <td>192</td> <td>154</td>	C	640	549	480	384	320	256	192	154
	4.0	3.70 <th>C</th> <td>739</td> <td>633</td> <td>554</td> <td>443</td> <td>370</td> <td>296</td> <td>222</td> <td>177</td>	C	739	633	554	443	370	296	222	177
	5.0	4.13 <th>C</th> <td>826</td> <td>708</td> <td>620</td> <td>496</td> <td>413</td> <td>330</td> <td>248</td> <td>198</td>	C	826	708	620	496	413	330	248	198
				SYNTAL-CT	371771 (12 pcs. 755634)			SYNTAL-S	371713 (12 pcs. 755664)		

The nozzles are available both as single nozzles (S) and as COLOR TIPS (CT), where the nozzle is integrated in the SNAP-FIT.

HARDI ISO LD-110 - LowDrift nozzles



LowDrift nozzles are recommended when optimum spraying conditions cannot be achieved (risk of drift) and spraying cannot be postponed.

- ISO – Flow, colour and outer dimensions
- Working pressure – 1.5 to 5 bar
- Restrictor designed for minimum chemical residues
- SYNTAL – precision moulded thermoplastic
- CERAMIC – extremely high durability
- COLOR TIPS – for safe and easy handling

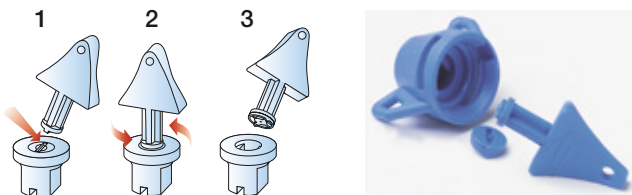

Turn-&-Clean with the HARDI key – easily removable restrictor.

This nozzle will give you excellent and uniform liquid distribution at boom heights from 35 to 70 cm (50 cm recommended to take care of uneven terrain or boom movements).

To ensure that the boom distribution is not disturbed by interference, the nozzles are set at an angle of 8° to the boom. This feature is built into all HARDI COLOR TIP and SNAP-FIT caps. This angle has to be set manually if single nozzles are used.

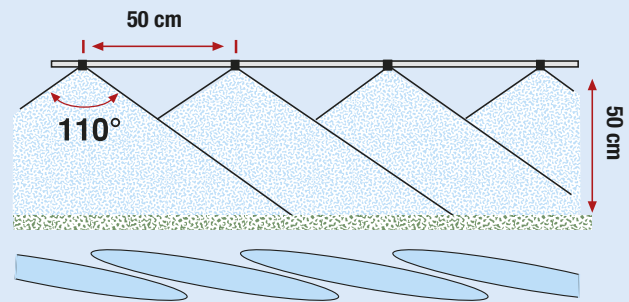

	bar	l/min	Spray quality	l/ha at km/h							
				6	7	8	10	12	15	20	25
01-Orange	1.5	0.28	M	57	48	42	34	28	23	17	14
	2.0	0.33	M	65	56	49	39	33	26	20	16
	2.5	0.37	M	73	63	55	44	37	29	22	18
	3.0	0.40	M	80	69	60	48	40	32	24	19
	4.0	0.46	M	92	79	69	55	46	37	28	22
	5.0	0.52	F	103	89	77	62	52	41	31	25
				SYNTAL-CT 371837 (12 pcs. 755708)				SYNTAL-S 371817 (12 pcs. 755698)			
				CERAMIC-CT 371842 (12 pcs. 755713)				CERAMIC-S 371822 (12 pcs. 755703)			

	bar	l/min	Spray quality	l/ha at km/h							
				6	7	8	10	12	15	20	25
015-Green	1.5	0.42	M	85	73	64	51	42	34	25	20
	2.0	0.49	M	98	84	73	59	49	39	29	24
	2.5	0.55	M	110	94	82	66	55	44	33	26
	3.0	0.60	M	120	103	90	72	60	48	36	29
	4.0	0.69	M	139	119	104	83	69	55	42	33
	5.0	0.77	M	155	133	116	93	77	62	46	37
				SYNTAL-CT 371838 (12 pcs. 755709)				SYNTAL-S 371818 (12 pcs. 755699)			
				CERAMIC-CT 371843 (12 pcs. 755714)				CERAMIC-S 371823 (12 pcs. 755704)			

	bar	l/min	Spray quality	l/ha at km/h							
				6	7	8	10	12	15	20	25
02-Yellow	1.5	0.57	M	113	97	85	68	57	45	34	27
	2.0	0.65	M	131	112	98	78	65	52	39	31
	2.5	0.73	M	146	125	110	88	73	58	44	35
	3.0	0.80	M	160	137	120	96	80	64	48	38
	4.0	0.92	M	185	158	139	111	92	74	55	44
	5.0	1.03	M	207	177	155	124	103	83	62	50
				SYNTAL-CT 371839 (12 pcs. 755710)				SYNTAL-S 371819 (12 pcs. 755700)			
				CERAMIC-CT 371844 (12 pcs. 755715)				CERAMIC-S 371824 (12 pcs. 755705)			

	bar	l/min	Spray quality	l/ha at km/h							
				6	7	8	10	12	15	20	25
025-Lilac	1.5	0.71	C	141	121	106	85	71	57	42	34
	2.0	0.82	C	163	140	122	98	82	65	49	39
	2.5	0.91	M	183	156	137	110	91	73	55	44
	3.0	1.00	M	200	171	150	120	100	80	60	48
	4.0	1.15	M	231	198	173	139	115	92	69	55
	5.0	1.29	M	258	221	194	155	129	103	77	62
				SYNTAL-CT 371958 (12 pcs. 750630)				SYNTAL-S 371957 (12 pcs. 750632)			

	bar	l/min	Spray quality	l/ha at km/h							
				6	7	8	10	12	15	20	25
03-Blue	1.5	0.85	C	170	145	127	102	85	68	51	41
	2.0	0.98	C	196	168	147	118	98	78	59	47
	2.5	1.10	C	219	188	164	131	110	88	66	53
	3.0	1.20	C	240	206	180	144	120	96	72	58
	4.0	1.39	M	277	238	208	166	139	111	83	67
	5.0	1.55	M	310	266	232	186	155	124	93	74
				SYNTAL-CT 371840 (12 pcs. 755711)				SYNTAL-S 371820 (12 pcs. 755701)			
				CERAMIC-CT 371845 (12 pcs. 755716)				CERAMIC-S 371825 (12 pcs. 755706)			

	bar	l/min	Spray quality	l/ha at km/h							
				6	7	8	10	12	15	20	25
04-Red	1.5	1.13	C	226	194	170	136	113	91	68	54
	2.0	1.31	C	261	224	196	157	131	105	78	63
	2.5	1.46	C	292	250	219	175	146	117	88	70
	3.0	1.60	C	320	274	240	192	160	128	96	77
	4.0	1.85	C	370	317	277	222	185	148	111	89
	5.0	2.07	M	413	354	310	248	207	165	124	99
				SYNTAL-CT 371841 (12 pcs. 755712)				SYNTAL-S 371821 (12 pcs. 755702)			
				CERAMIC-CT 371846 (12 pcs. 755717)				CERAMIC-S 371826 (12 pcs. 755707)			

	bar	l/min	Spray quality	l/ha at km/h							
				6	7	8	10	12	15	20	25
05-Brown	1.5	1.41	C	283	242	212	170	141	113	85	68
	2.0	1.63	C	327	280	245	196	163	131	98	78
	2.5	1.83	C	365	313	274	219	183	146	110	88
	3.0	2.00	C	400	343	300	240	200	160	120	96
	4.0	2.31	C	462	396	346	277	231	185	139	111
	5.0	2.58	C	516	443	387	310	258	207	155	124
				SYNTAL-CT 371894 (12 pcs. 755815)				SYNTAL-S 371893 (12 pcs. 755817)			
				CERAMIC-CT 371897 (12 pcs. 755816)				CERAMIC-S 371896 (12 pcs. 755818)			

= Spray quality:
 Fine (F), Medium (M), Coarse (C), Very Coarse (VC).

The nozzles are available both as single nozzles (S) and as COLOR TIPS (CT), where the nozzle is integrated in the SNAP-FIT.



HARDI ISO MINIDRIFT air inclusion nozzles



The HARDI MINIDRIFT nozzles can be used for spraying at sub-optimal weather conditions, when spraying cannot be postponed. The MINIDRIFT nozzle will at low pressures reduce drift to a minimum.

- Air inclusion nozzle
- Working pressure – 1 to 6 bar
- ISO – flow, colours, sizes and nomenclature
- Application rates from 60 to 430 l/ha (at 8 km/h)
- SYNTAL – precision moulded thermoplastic

This nozzle will give you excellent and uniform liquid distribution at boom heights from 40 to 90 cm.

The droplet spectrum is coarse to very coarse; safe for drift control but without risking poor coverage and deposition on leaves.

The venturi can easily be removed for cleaning the nozzle.

Spray liquid

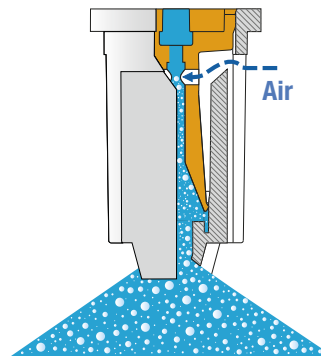

Two big air inlets reduce the risk of clogging.

Compact design reduces impact damage.

Meets full ISO specifications.

	bar	l/min	i	l/ha at km/h									
				6	7	8	10	12	15	20	25		
015-Green	1.5	0.42	C	85	73	64	51	42	34	25	20		
	2.0	0.49	C	98	84	73	59	49	39	29	24		
	2.5	0.55	C	110	94	82	66	55	44	33	26		
	3.0	0.60	C	120	103	90	72	60	48	36	29		
	4.0	0.69	M	139	119	104	83	69	55	42	33		
	5.0	0.77	M	155	133	116	93	77	62	46	37		
	6.0	0.85	M	170	145	127	102	85	68	51	41		
				SYNTAL-CT 372121 (12 pcs. 75083100)				SYNTAL-S 372111 (12 pcs. 75082100)					

	bar	l/min	i	l/ha at km/h									
				6	7	8	10	12	15	20	25		
03-Blue	1.5	0.85	VC	170	145	127	102	85	68	51	41		
	2.0	0.98	VC	196	168	147	118	98	78	59	47		
	2.5	1.10	VC	219	188	164	131	110	88	66	53		
	3.0	1.20	C	240	206	180	144	120	96	72	58		
	4.0	1.39	C	277	238	208	166	139	111	83	67		
	5.0	1.55	C	310	266	232	186	155	124	93	74		
	6.0	1.70	M	339	291	255	204	170	136	102	81		
				SYNTAL-CT 372124 (12 pcs. 75083400)				SYNTAL-S 372114 (12 pcs. 75082400)					

	bar	l/min	i	l/ha at km/h									
				6	7	8	10	12	15	20	25		
02-Yellow	1.5	0.57	VC	113	97	85	68	57	45	34	27		
	2.0	0.65	C	131	112	98	78	65	52	39	31		
	2.5	0.73	C	146	125	110	88	73	58	44	35		
	3.0	0.80	C	160	137	120	96	80	64	48	38		
	4.0	0.92	C	185	158	139	111	92	74	55	44		
	5.0	1.03	M	207	177	155	124	103	83	62	50		
	6.0	1.13	M	226	194	170	136	113	91	68	54		
				SYNTAL-CT 372122 (12 pcs. 75083200)				SYNTAL-S 372112 (12 pcs. 75082200)					

	bar	l/min	i	l/ha at km/h									
				6	7	8	10	12	15	20	25		
04-Red	1.0	0.92	VC	185	158	139	111	90	74	55	44		
	1.5	1.13	VC	226	194	170	136	113	91	68	54		
	2.0	1.31	VC	261	224	196	157	131	105	78	63		
	2.5	1.46	VC	292	250	219	175	146	117	88	70		
	3.0	1.60	VC	320	274	240	192	160	128	96	77		
	4.0	1.85	C	370	317	277	222	185	148	111	89		
	5.0	2.07	C	413	354	310	248	207	165	124	99		
	6.0	2.26	C	453	388	339	272	226	181	136	109		
				SYNTAL-CT 372125 (12 pcs. 75083500)				SYNTAL-S 372115 (12 pcs. 75082500)					

	bar	l/min	i	l/ha at km/h									
				6	7	8	10	12	15	20	25		
025-Lilac	1.5	0.71	VC	141	121	106	85	71	57	42	34		
	2.0	0.82	VC	163	140	122	98	82	65	49	39		
	2.5	0.91	C	183	156	137	110	91	73	55	44		
	3.0	1.00	C	200	171	150	120	100	80	60	48		
	4.0	1.15	C	231	198	173	139	115	92	69	55		
	5.0	1.29	M	258	221	194	155	129	103	77	62		
	6.0	1.41	M	283	242	212	170	141	113	85	68		
				SYNTAL-CT 372123 (12 pcs. 75083300)				SYNTAL-S 372113 (12 pcs. 75082300)					

	bar	l/min	i	l/ha at km/h									
				6	7	8	10	12	15	20	25		
05-Brown	1.0	1.15	VC	231	198	173	139	115	92	69	55		
	1.5	1.41	VC	283	242	212	170	141	113	85	68		
	2.0	1.63	VC	327	280	245	196	163	131	98	78		
	2.5	1.83	VC	365	313	274	219	183	146	110	88		
	3.0	2.00	VC	400	343	300	240	200	160	120	96		
	4.0	2.31	C	462	396	346	277	231	185	139	111		
	5.0	2.58	C	516	443	387	310	258	207	155	124		
	6.0	2.83	C	566	485	424	339	283	226	170	136		
				SYNTAL-CT 372126 (12 pcs. 75083600)				SYNTAL-S 372116 (12 pcs. 75082600)					

= Spray quality:
 Fine (F), Medium (M), Coarse (C), Very Coarse (VC).

The nozzles are available both as single nozzles (S) and as COLOR TIPS (CT), where the nozzle is integrated in the SNAP-FIT.

HARDI ISO INJET air inclusion nozzles



The HARDI INJET nozzles can be used for spraying at sub-optimal weather conditions, or when spraying cannot be postponed. The HARDI INJET nozzles are recommended for most pesticide applications where reduced risk of drift is demanded.

- Air inclusion nozzles with greater drift reduction
- ISO flow, colours and nomenclature
- Application rates from 60 – 600 l/ha (at 8 km/h)
- Pressure range – 3-8 bar
- B-Jet border nozzle for precise application near sensitive areas
- Available in SYNTAL and CERAMIC materials

The HARDI INJET & B-JET nozzles can be mounted using the 334083 ISO/INJET cap.

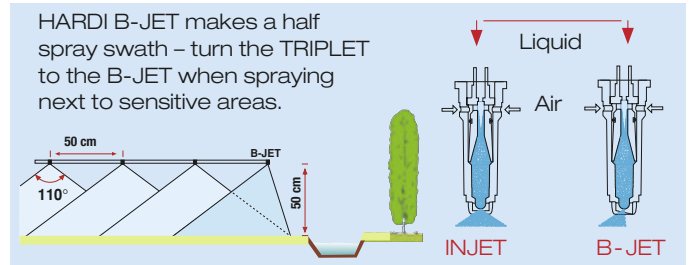

			l/ha at km/h								
	bar	l/min	6	7	8	10	12	15	20	25	
01-Orange	3.0	0.40	VC	80	69	60	48	40	32	24	19
	4.0	0.46	VC	92	79	69	55	46	37	28	22
	5.0	0.52	VC	103	89	77	62	52	41	31	25
	6.0	0.57	C	113	97	85	68	57	45	34	27
	7.0	0.61	C	122	105	92	73	61	49	37	29
	8.0	0.65	C	131	112	98	78	65	52	39	31
SYNTAL-S			371926 (12 pcs. 75078800)								

			l/ha at km/h								
	bar	l/min	6	7	8	10	12	15	20	25	
015-Green	3.0	0.60	VC	120	103	90	72	60	48	36	29
	4.0	0.69	VC	139	119	104	83	69	55	42	33
	5.0	0.77	VC	155	133	116	93	77	62	46	37
	6.0	0.85	VC	170	145	127	102	85	68	51	41
	7.0	0.92	VC	183	157	137	110	92	73	55	44
	8.0	0.98	C	196	168	147	118	98	78	59	47
SYNTAL-S			371872 (12 pcs. 75081500)								

			l/ha at km/h								
	bar	l/min	6	7	8	10	12	15	20	25	
02-Yellow	3.0	0.80	VC	160	137	120	96	80	64	48	38
	4.0	0.92	VC	185	158	139	111	92	74	55	44
	5.0	1.03	VC	207	177	155	124	103	83	62	50
	6.0	1.13	VC	226	194	170	136	113	91	68	54
	7.0	1.22	VC	244	209	183	147	122	98	73	59
	8.0	1.31	VC	261	224	196	157	131	105	78	63
SYNTAL-S			371873 (12 pcs. 75081600)				SYNTAL-S B-JET 371930 (2 pcs. 750620)				

			l/ha at km/h								
	bar	l/min	6	7	8	10	12	15	20	25	
025-Lilac	3.0	1.00	VC	200	171	150	120	100	80	60	48
	4.0	1.15	VC	231	198	173	139	115	92	69	55
	5.0	1.29	VC	258	221	194	155	129	103	77	62
	6.0	1.41	VC	283	242	212	170	141	113	85	68
	7.0	1.53	VC	306	262	229	183	153	122	92	73
	8.0	1.63	VC	327	280	245	196	163	131	98	78
SYNTAL-S			371874 (12 pcs. 75081700)				SYNTAL-S B-JET 371877 (2 pcs. 755806)				

			l/ha at km/h								
	bar	l/min	6	7	8	10	12	15	20	25	
03-Blue	3.0	1.20	VC	240	206	180	144	120	96	72	58
	4.0	1.39	VC	277	238	208	166	139	111	83	67
	5.0	1.55	VC	310	266	232	186	155	124	93	74
	6.0	1.70	VC	339	291	255	204	170	136	102	81
	7.0	1.83	VC	367	314	275	220	183	147	110	88
	8.0	1.96	VC	392	336	294	235	196	157	118	94
SYNTAL-S			371875 (12 pcs. 75081800)				SYNTAL-S B-JET 371870 (2 pcs. 755799)				

			l/ha at km/h								
	bar	l/min	6	7	8	10	12	15	20	25	
04-Red	3.0	1.60	VC	320	274	240	192	160	128	96	77
	4.0	1.85	VC	370	317	277	222	185	148	111	89
	5.0	2.07	VC	413	354	310	248	207	165	124	99
	6.0	2.26	VC	453	388	339	272	226	181	136	109
	7.0	2.44	VC	489	419	367	293	244	196	147	117
	8.0	2.61	VC	523	448	392	314	261	209	157	125
SYNTAL-S			371876 (12 pcs. 75081900)				SYNTAL-S B-JET 371871 (2 pcs. 755800)				

			l/ha at km/h								
	bar	l/min	6	7	8	10	12	15	20	25	
05-Brown	3.0	2.00	VC	400	343	300	240	200	160	120	96
	4.0	2.31	VC	462	396	346	277	231	185	139	111
	5.0	2.58	VC	516	443	387	310	258	207	155	124
	6.0	2.83	VC	566	485	424	339	283	226	170	136
	7.0	3.06	VC	611	524	458	367	306	244	183	147
	8.0	3.27	VC	653	560	490	392	327	261	196	157
SYNTAL-S			371927 (12 pcs. 75078900)								

			l/ha at km/h								
	bar	l/min	6	7	8	10	12	15	20	25	
06-Grey	3.0	2.40	VC	480	411	360	288	240	192	144	115
	4.0	2.77	VC	554	475	416	333	277	222	166	133
	5.0	3.10	VC	620	531	465	372	310	248	186	149
	6.0	3.39	VC	679	582	509	407	339	272	204	163
	7.0	3.67	VC	733	628	550	440	367	293	220	176
	8.0	3.92	VC	784	672	588	470	392	314	235	188
SYNTAL-S			371928 (12 pcs. 7507900)								

			l/ha at km/h								
	bar	l/min	6	7	8	10	12	15	20	25	
08-White	3.0	3.20	VC	640	549	480	384	320	256	192	154
	4.0	3.70	VC	739	633	554	443	370	296	222	177
	5.0	4.13	VC	826	708	620	496	413	330	248	198
	6.0	4.53	VC	905	776	679	543	453	362	272	217
	7.0	4.89	VC	978	838	733	587	489	391	293	235
	8.0	5.23	VC	1045	896	784	627	523	418	314	251
SYNTAL-S			371929 (12 pcs. 75079100)								

= Spray quality:
 Fine (F), Medium (M), Coarse (C), Very Coarse (VC).

The nozzles are available both as single nozzles (S) and as COLOR TIPS (CT), where the nozzle is integrated in the SNAP-FIT.



HARDI ISO MINIDRIFT DUO air inclusion nozzles



The HARDI MINIDRIFT DUO nozzle can be used for spraying at sub-optimal weather conditions, when spraying cannot be postponed. The MINIDRIFT DUO nozzle will at low pressures reduce drift to a minimum.

Air inclusion nozzle

- Working pressure – 1.5 to 6 bar ISO flow, colours, sizes and nomenclature
- 30° forward and backward angle
- Application rates from 125 to 420 l/ha (at 8 km/h)
- SYNTAL – precision moulded thermoplastic

This compact flat spray air injector nozzle offers droplet spectrum from medium to very coarse; safe for drift control but without risking poor coverage and deposition on leaves. The two angled fans increase the number of droplets and impacts on target compared to normal air injector nozzles.

A good coverage on dense foliage and vertical targets. The injector can easily be removed for cleaning the nozzle.

The HARDI MINIDRIFT DUO nozzles can be mounted using the 334083 ISO cap.



	bar	l/min		l/ha at km/h							
				6	7	8	10	12	14	16	18
02-Yellow	1.5	0.57	VC	113	97	85	68	57	45	34	27
	2.0	0.65	C	131	112	98	78	65	52	39	31
	2.5	0.73	C	146	125	110	88	73	58	44	35
	3.0	0.80	C	160	137	120	96	80	64	48	38
	4.0	0.92	C	185	158	139	111	92	74	55	44
	5.0	1.03	M	207	177	155	124	103	83	62	50
	6.0	1.13	M	226	194	170	136	113	91	68	54
SYNTAL-S				37218400							

025-Lilac	1.5	0.71	VC	141	121	106	85	71	57	42	34
	2.0	0.82	VC	163	140	122	98	82	65	49	39
	2.5	0.91	C	183	156	137	110	91	73	55	44
	3.0	1.00	C	200	171	150	120	100	80	60	48
	4.0	1.15	C	231	198	173	139	115	92	69	55
	5.0	1.29	M	258	221	194	155	129	103	77	62
	6.0	1.41	M	283	242	212	170	141	113	85	68
SYNTAL-S				37218500							

03-Blue	1.5	0.84	VC	168	144	126	101	84	72	63	56
	2.0	0.97	VC	194	166	146	116	97	83	73	65
	2.5	1.08	C	216	185	162	130	108	93	81	72
	3.0	1.19	C	238	204	179	143	119	102	89	79
	4.0	1.37	M	274	235	206	164	137	117	103	91
	5.0	1.53	M	310	266	232	186	155	124	93	74
	6.0	1.68	M	336	288	252	202	168	144	126	112
SYNTAL-S				37218100							

04-Red	1.5	1.12	VC	224	192	168	134	112	96	84	75
	2.0	1.29	C	258	221	194	155	129	111	97	86
	2.5	1.44	C	288	247	216	173	144	123	108	96
	3.0	1.58	C	316	271	237	190	158	135	119	105
	4.0	1.82	M	364	312	273	218	182	156	137	121
	5.0	2.04	M	408	350	306	245	204	175	153	136
	6.0	2.23	M	446	382	335	268	223	191	167	149
SYNTAL-S				37218200							

05-Brown	1.5	1.39	VC	278	238	209	167	139	119	104	93
	2.0	1.61	C	322	276	242	193	161	138	121	107
	2.5	1.80	C	360	309	270	216	180	154	135	120
	3.0	1.97	C	394	338	296	236	197	169	148	131
	4.0	2.28	M	456	391	342	274	228	195	171	152
	5.0	2.55	M	510	437	383	306	255	219	191	170
	6.0	2.79	M	558	478	419	335	279	239	209	186
SYNTAL-S				37218300							

= Spray quality:
■ Fine (F), ■ Medium (M), ■ Coarse (C), ■ Very Coarse (VC).

HARDI DUOCAP



Double-up your application

- Improved coverage
- Angled spray ensures penetration in dense crops
- Can hold all ISO nozzles
- 30° forward and backward angle

HARDI DUOCAP gives you higher volume rate while still maintaining proper droplet size

Fitted with two F or LD nozzles HARDI DUOCAP will give Fine to Medium spray, suitable for fungicide spraying.

Two different nozzles can be used. A Standard and a MINIDRIFT nozzle will give you the dual benefit of having Fine droplets, ensuring good coverage in the top of the crop and Coarse droplets, penetrating to the lower and more dense areas.

HARDI DUOCAP fitted with two MINIDRIFT nozzles will give superior penetration into dense crops like Potatoes and Soybeans.

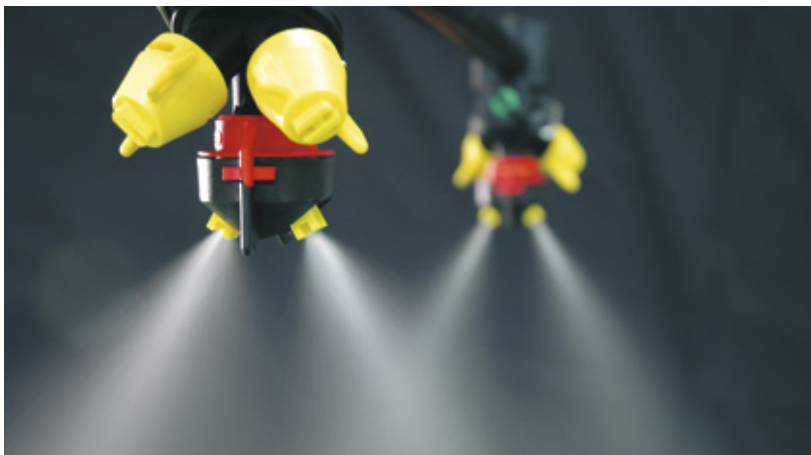
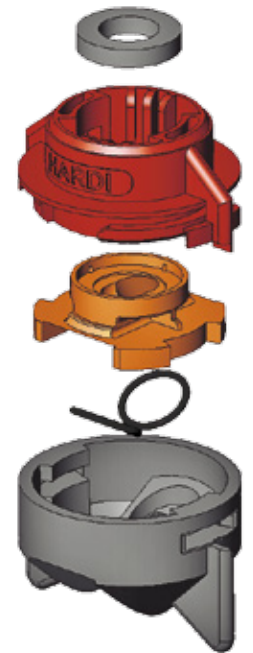

Calibration

If two ISO nozzles of the same size are used, they will apply the same volume as one ISO nozzle of the double size (use the application table of the double sized nozzle). If two nozzles of different sizes are used, the l/min at the chosen pressure for both nozzles must be added together, and the table below can be used to find the application volume.

l/min (2 nozzles)	l/ha at km/h							
	6	7	8	10	12	15	20	25
0.75	150	129	113	90	75	60	45	36
1.00	200	171	150	120	100	80	60	48
1.25	250	214	188	150	125	100	75	60
1.50	300	257	225	180	150	120	90	72
1.75	350	300	263	210	175	140	105	84
2.00	400	343	300	240	200	160	120	96
2.25	450	386	338	270	225	180	135	108
2.50	500	429	375	300	250	200	150	120
2.75	550	471	413	330	275	220	165	132
3.00	600	514	450	360	300	240	180	144
3.25	650	557	488	390	325	260	195	156
3.50	700	600	525	420	350	280	210	168
3.75	750	643	563	450	375	300	225	180
4.00	800	686	600	480	400	320	240	192
4.25	850	729	638	510	425	340	255	204
4.50	900	771	675	540	450	360	270	216
4.75	950	814	713	570	475	380	285	228
5.00	1000	857	750	600	500	400	300	240
5.25	1050	900	788	630	525	420	315	252
5.50	1100	943	825	660	550	440	330	264
5.75	1150	986	863	690	575	460	345	276
6.00	1200	1029	900	720	600	480	360	288

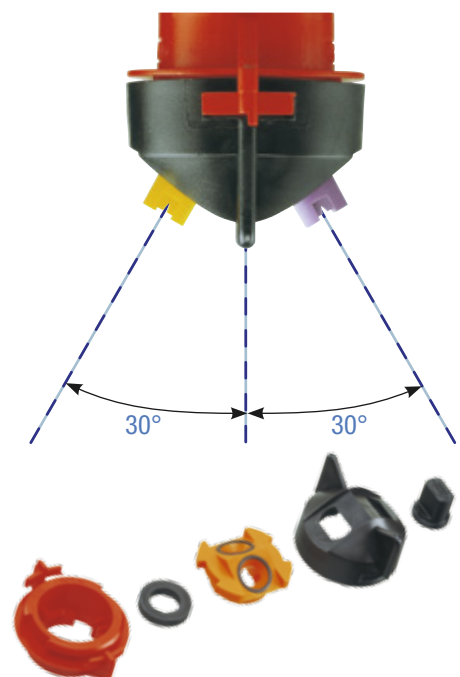

The HARDI DUOCAP is delivered complete with 3 O-rings, and 3 plastic parts (note: nozzles are not included). (réf. 28063000).

HARDI ISO F-80 – Flat fan nozzles



This nozzle has an 80° spray angle. On boom sizes from 24 to 36 m the boom height is often higher than 50 cm above the target. 80° nozzles provide good coverage with reduced drift risk at these higher boom heights and are also adaptable to band spraying.

- ISO – flow, colour and outer dimensions
- Spray angle – 80°
- Working pressure – 1.5 to 5 bar
- SYNTAL – precision moulded thermoplastic
- CERAMIC – extremely high durability

The 80° nozzle is suitable for big booms or row crop / band spraying with either low boom or nozzles at droplegs.

For use in cotton, sugar cane, sugar beets etc. The 80° nozzles can be fitted on HARDI sprayers using the 334083 ISO/INJET cap.

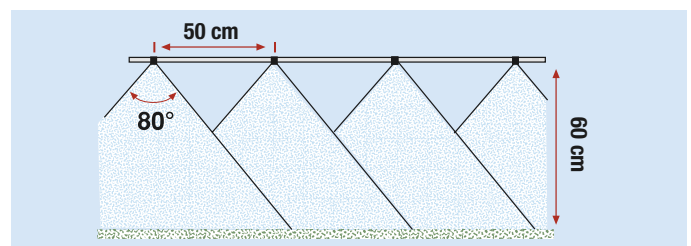

	bar	l/min	l/ha at km/h								
			6	7	8	10	12	15	20	25	
01-Orange	1.5	0.28	-	57	48	42	34	28	23	17	14
	2.0	0.33	-	65	56	49	39	33	26	20	16
	2.5	0.37	-	73	63	55	44	37	29	22	18
	3.0	0.40	-	80	69	60	48	40	32	24	19
	4.0	0.46	-	92	79	69	55	46	37	28	22
	5.0	0.52	-	103	89	77	62	52	41	31	25
			SYNTAL-S 371931 (12 pcs. 750640)								

	bar	l/min	l/ha at km/h								
			6	7	8	10	12	15	20	25	
02-Yellow	1.5	0.57	-	113	97	85	68	57	45	34	27
	2.0	0.65	-	131	112	98	78	65	52	39	31
	2.5	0.73	-	146	125	110	88	73	58	44	35
	3.0	0.80	-	160	137	120	96	80	64	48	38
	4.0	0.92	-	185	158	139	111	92	74	55	44
	5.0	1.03	-	207	177	155	124	103	83	62	50
			SYNTAL-S 371933 (12 pcs. 750642)				CERAMIC-CT 371921 (12 pcs. 750603)				
			CERAMIC-S 371907 (12 pcs. 750610)								

	bar	l/min	l/ha at km/h								
			6	7	8	10	12	15	20	25	
015-Green	1.5	0.42	-	85	73	64	51	42	34	25	20
	2.0	0.49	-	98	84	73	59	49	39	29	24
	2.5	0.55	-	110	94	82	66	55	44	33	26
	3.0	0.60	-	120	103	90	72	60	48	36	29
	4.0	0.69	-	139	119	104	83	69	55	42	33
	5.0	0.77	-	155	133	116	93	77	62	46	37
			SYNTAL-S 371932 (12 pcs. 750641)				CERAMIC-CT 371920 (12 pcs. 750602)				
			CERAMIC-S 371906 (12 pcs. 750609)								

	bar	l/min	l/ha at km/h								
			6	7	8	10	12	15	20	25	
03-Blue	1.5	0.85	-	170	145	127	102	85	68	51	41
	2.0	0.98	-	196	168	147	118	98	78	59	47
	2.5	1.10	-	219	188	164	131	110	88	66	53
	3.0	1.20	-	240	206	180	144	120	96	72	58
	4.0	1.39	-	277	238	208	166	139	111	83	67
	5.0	1.55	-	310	266	232	186	155	124	93	74
			SYNTAL-S 371934 (12 pcs. 750643)				CERAMIC-CT 371922 (12 pcs. 750604)				
			CERAMIC-S 371908 (12 pcs. 750611)								

= Spray quality:
 Fine (F), Medium (M), Coarse (C), Very Coarse (VC).

The nozzles are available both as single nozzles (S) and as COLOR TIPS (CT), where the nozzle is integrated in the SNAP-FIT.



HARDI QUINTASTREAM nozzles



Five [5] streams of liquid are distributed at different angles and flows by each Quintastream nozzle. Highest flow is from the middle stream and lowest in the outer, overlapping streams. HARDI QUINTASTREAM can be mounted using the filter casing without gasket (725737).

- The fastest way to convert your sprayer into a high precision fertilizer applicator
- 5 solid streams that minimise crop scorching
- Particularly important for wide booms at fast speeds
- ISO standard for easy calibration
- Turn and Clean key for restrictor removal
- Boom height 35-100 cm

Uniquely, this - patent pending - system allows for boom movements that do not influence distribution.

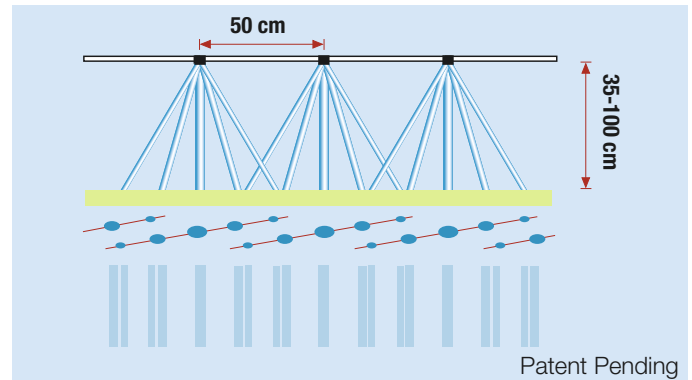

	bar	l/min	l/ha at km/h								
			6	7	8	10	12	15	20	25	
015-Green	1.5	0.42	-	85	73	64	51	42	34	25	20
	2.0	0.49	-	98	84	73	59	49	39	29	24
	2.5	0.55	-	110	94	82	66	55	44	33	26
	3.0	0.60	-	120	103	90	72	60	48	36	29
	4.0	0.69	-	139	119	104	83	69	55	42	33
	5.0	0.77	-	155	133	116	93	77	62	46	37
			COLORTIP	372011 (6 pcs. 750680)				SINGLE 372002 (6 pcs. 750671)			

	bar	l/min	l/ha at km/h								
			6	7	8	10	12	15	20	25	
06-Grey	1.5	1.70	-	339	291	255	204	170	136	102	81
	2.0	1.96	-	392	336	294	235	196	157	118	94
	2.5	2.19	-	438	376	329	263	219	175	131	105
	3.0	2.40	-	480	411	360	288	240	192	144	115
	4.0	2.77	-	554	475	416	333	277	222	166	133
	5.0	3.10	-	620	531	465	372	310	248	186	149
			COLORTIP	372016 (6 pcs. 750685)				SINGLE 372007 (6 pcs. 750676)			

	bar	l/min	l/ha at km/h								
			6	7	8	10	12	15	20	25	
02-Yellow	1.5	0.57	-	113	97	85	68	57	45	34	27
	2.0	0.65	-	131	112	98	78	65	52	39	31
	2.5	0.73	-	146	125	110	88	73	58	44	35
	3.0	0.80	-	160	137	120	96	80	64	48	38
	4.0	0.92	-	185	158	139	111	92	74	55	44
	5.0	1.03	-	207	177	155	124	103	83	62	50
			COLORTIP	372012 (6 pcs. 750681)				SINGLE 372003 (6 pcs. 750672)			

	bar	l/min	l/ha at km/h								
			6	7	8	10	12	15	20	25	
08-White	1.5	2.26	-	453	388	339	272	226	181	136	109
	2.0	2.61	-	523	448	392	314	261	209	157	125
	2.5	2.92	-	584	501	438	351	292	234	175	140
	3.0	3.20	-	640	549	480	384	320	256	192	154
	4.0	3.70	-	739	633	554	443	370	296	222	177
	5.0	4.13	-	826	708	620	496	413	330	248	198
			COLORTIP	372017 (6 pcs. 750686)				SINGLE 372008 (6 pcs. 750677)			

	bar	l/min	l/ha at km/h								
			6	7	8	10	12	15	20	25	
03-Blue	1.5	0.85	-	170	145	127	102	85	68	51	41
	2.0	0.98	-	196	168	147	118	98	78	59	47
	2.5	1.10	-	219	188	164	131	110	88	66	53
	3.0	1.20	-	240	206	180	144	120	96	72	58
	4.0	1.39	-	277	238	208	166	139	111	83	67
	5.0	1.55	-	310	266	232	186	155	124	93	74
			COLORTIP	372013 (6 pcs. 750682)				SINGLE 372004 (6 pcs. 750673)			

	bar	l/min	l/ha at km/h								
			6	7	8	10	12	15	20	25	
10-Light blue	1.5	2.83	-	566	485	424	339	283	226	170	136
	2.0	3.27	-	653	560	490	392	327	261	196	157
	2.5	3.65	-	730	626	548	438	365	292	219	175
	3.0	4.00	-	800	686	600	480	400	320	240	192
	4.0	4.62	-	924	792	693	554	462	370	277	222
	5.0	5.16	-	1033	885	775	620	516	413	310	248
			COLORTIP	372018 (6 pcs. 750687)				SINGLE 372009 (6 pcs. 750678)			

	bar	l/min	l/ha at km/h								
			6	7	8	10	12	15	20	25	
04-Red	1.5	1.13	-	226	194	170	136	113	91	68	54
	2.0	1.31	-	261	224	196	157	131	105	78	63
	2.5	1.46	-	292	250	219	175	146	117	88	70
	3.0	1.60	-	320	274	240	192	160	128	96	77
	4.0	1.85	-	370	317	277	222	185	148	111	89
	5.0	2.07	-	413	354	310	248	207	165	124	99
			COLORTIP	372014 (6 pcs. 750683)				SINGLE 372005 (6 pcs. 750674)			

	bar	l/min	l/ha at km/h								
			6	7	8	10	12	15	20	25	
15-Light green	1.5	4.24	-	849	727	636	509	424	339	255	204
	2.0	4.90	-	980	840	735	588	490	392	294	235
	2.5	5.48	-	1095	939	822	657	548	438	329	263
	3.0	6.00	-	1200	1029	900	720	600	480	360	288
	4.0	6.93	-	1386	1188	1039	831	693	554	416	333
	5.0	7.75	-	1549	1328	1162	930	775	620	465	372
			COLORTIP	372019 (6 pcs. 750688)				SINGLE 372010 (6 pcs. 750679)			

	bar	l/min	l/ha at km/h								
			6	7	8	10	12	15	20	25	
05-Brown	1.5	1.41	-	283	242	212	170	141	113	85	68
	2.0	1.63	-	327	280	245	196	163	131	98	78
	2.5	1.83	-	365	313	274	219	183	146	110	88
	3.0	2.00	-	400	343	300	240	200	160	120	96
	4.0	2.31	-	462	396	346	277	231	185	139	111
	5.0	2.58	-	516	443	387	310	258	207	155	124
			COLORTIP	372015 (6 pcs. 750684)				SINGLE 372006 (6 pcs. 750675)			

NOTE: Remember to adjust the pressure according to the density of the liquid fertilizer. See page 9.



Liquid fertilizer

1553 Solid stream nozzle

HARDI 1553 Cone nozzles are used without swirl plates for solid stream and with swirl plates for hollow cone and full cone spraying.

Use the solid stream for liquid fertilizer on boom sprayers.



- For application of liquid fertilizer at 25 cm nozzle spacing, with a minimum risk of scorching
- Flow rates from 0.29 – 22 l/min (at 1–10 bar)
- SYNTAL – precision moulded thermo-plastic: precise, resistant and durable

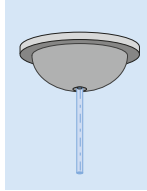

bar	l/min											
	1553-8	-10	-12	-14	-16	-18	-20	-22	-24	-30	-35	-40
1.0	0.29	0.42	0.65	0.85	1.12	1.39	1.71	2.03	2.37	3.61	5.18	7.01
1.5	0.36	0.51	0.79	1.04	1.37	1.70	2.09	2.48	2.90	4.42	6.34	8.59
2.0	0.41	0.59	0.92	1.20	1.58	1.96	2.42	2.87	3.35	5.10	7.32	9.92
3.0	0.50	0.72	1.12	1.46	1.94	2.40	2.96	3.51	4.10	6.25	8.97	12.15
5.0	0.65	0.93	1.45	1.89	2.50	3.10	3.82	4.53	5.29	8.07	11.58	15.68
6.0	0.71	1.02	1.59	2.07	2.74	3.40	4.18	4.96	5.79	8.84	12.69	17.18
10.0	0.92	1.32	2.05	2.67	3.54	4.38	5.40	6.41	7.48	11.41	16.38	22.17
15.0	1.13	1.61	2.51	3.27	4.33	5.37	6.62	7.85	9.16	13.98	20.06	27.16
25.0	1.45	2.08	3.24	4.23	5.59	6.93	8.54	10.13	11.83	18.05	25.89	35.06
No.	370016	370027	370031	370042	370053	370064	370075	370086	370097	370101	370112	370123
12 pcs.	750256	755031	755382	755064	755385	755065	755097	755066	755123	750257	755067	755068



Large drop flat spray nozzle

HARDI foam nozzles are excellent for application of liquid fertilizers. Choose foam nozzles for broad leaf application - the large air inclusion bubbles will be reflected on the leaves and minimize crop damage.

The nozzle is used in combination with the 1553 Solid Stream nozzle.

- Spray angle up to 150°
- Extremely coarse droplet spectrum
- Superior distribution
- Can work at nozzle spacing up to 100 cm

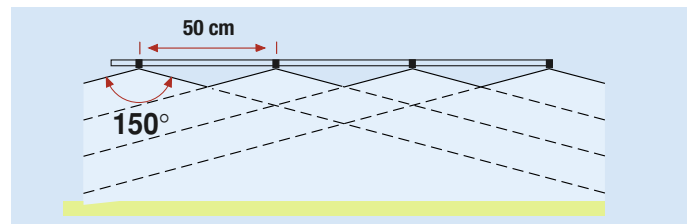

bar	l/min	l/ha at km/h									
		4	5	6	7	8	9	10	12	16	
1.0	0.84	253	202	169	145	127	112	101	84	63	
1.5	1.03	310	248	207	177	155	138	124	103	77	
2.0	1.19	358	286	239	204	179	159	143	119	89	
3.0	1.46	438	351	292	250	219	195	175	146	110	
4.0	1.69	506	405	337	289	253	225	202	169	127	
5.0	1.89	566	453	377	323	283	251	226	189	141	
Large drop flat spray nozzle (371551) + 1553-14 Grey (370042)											

bar	l/min	l/ha at km/h									
		4	5	6	7	8	9	10	12	16	
1.0	1.86	558	446	372	319	279	248	223	186	139	
1.5	2.28	683	546	455	390	341	303	273	228	171	
2.0	2.63	788	631	526	451	394	350	315	263	197	
3.0	3.22	966	773	644	552	483	429	386	322	241	
4.0	3.72	1115	892	743	637	558	496	446	372	279	
5.0	4.16	1247	997	831	712	623	554	499	416	312	
Large drop flat spray nozzle (371551) + 1553-20 Grey (370075)											

bar	l/min	l/ha at km/h									
		4	5	6	7	8	9	10	12	16	
1.0	1.15	346	277	231	198	173	154	138	115	87	
1.5	1.41	424	339	283	242	212	188	170	141	106	
2.0	1.63	490	392	326	280	245	218	196	163	122	
3.0	2.00	600	480	400	343	300	267	240	200	150	
4.0	2.31	692	554	462	396	346	308	277	231	173	
5.0	2.58	774	619	516	422	387	344	310	258	194	
Large drop flat spray nozzle (371551) + 1553-16 Grey (370053)											

bar	l/min	l/ha at km/h									
		4	5	6	7	8	9	10	12	16	
1.0	2.23	688	534	445	382	334	297	267	223	167	
1.5	2.73	818	654	545	467	409	364	327	273	204	
2.0	3.15	945	756	630	540	472	420	378	315	236	
3.0	3.86	1157	925	771	661	578	514	463	386	289	
4.0	4.45	1336	1069	891	763	668	594	534	445	334	
5.0	4.98	1493	1195	996	853	747	664	597	498	373	
Large drop flat spray nozzle (371551) + 1553-22 Grey (370086)											

bar	l/min	l/ha at km/h									
		4	5	6	7	8	9	10	12	16	
1.0	1.38	415	332	277	237	208	185	166	138	104	
1.5	1.69	508	407	339	291	254	226	203	169	127	
2.0	1.96	587	470	391	336	294	261	235	196	147	
3.0	2.40	719	575	479	411	360	320	288	240	180	
4.0	2.77	830	664	554	474	415	369	332	277	208	
5.0	3.09	928	743	619	530	464	413	371	309	232	
Large drop flat spray nozzle (371551) + 1553-18 Grey (370064)											

bar	l/min	l/ha at km/h									
		4	5	6	7	8	9	10	12	16	
1.0	2.60	780	624	520	446	390	347	312	260	195	
1.5	3.19	956	765	637	546	478	425	382	319	239	
2.0	3.68	1104	883	736	631	552	491	441	368	276	
3.0	4.51	1352	1081	901	772	676	601	541	451	338	
4.0	5.20	1561	1249	1041	892	780	694	624	520	390	
5.0	5.82	1745	1396	1163	997	873	776	698	582	436	
Large drop flat spray nozzle (371551) + 1553-24 Grey (370097)											

NOTE: Remember to adjust the pressure according to the density of the liquid fertilizer. See page 9.

Calibration of mistblowers

1 Calibration of forward speed

See page 8: Calibration of field sprayers (note that the tractor PTO should be 540 rpm, which will allow the blower to operate at its maximum capacity)

2 Calculation of nozzle size and pressure

After determining your forward speed and choosing your application rate according to the recommendations on the chemical container, the total nozzle capacity can be calculated on the following formula (based on driving in each row):

$$\frac{\text{row spacing (m)} \times \text{l/ha} \times \text{km/h}}{600} = \text{total l/min}$$

Example Row spacing: 5 m
Application rate: 600 l/ha
Forward speed: 4 km/h

$$\frac{5 \text{ m} \times 600 \text{ l/ha} \times 4 \text{ km/h}}{600} = 20 \text{ l/min}$$

The total nozzle capacity is 20 l/min. This amount has to be divided between all the nozzles on the mistblower. Two examples are described below:

(A) Nozzle calibration when equal output from each nozzle is desired.

From the drawing you can see that the output from each of the 20 nozzles are the same, because the foliage to be sprayed is evenly distributed. This is calculated as follows:

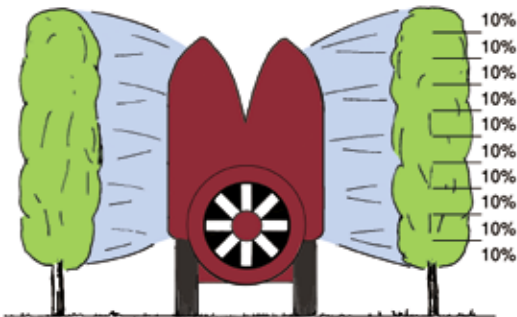

$$\frac{\text{total l/min}}{\text{number of nozzles}} = \text{capacity of single nozzle in l/min}$$

Example
 $\frac{20 \text{ l/min}}{20 \text{ nozzles}} = 1 \text{ l/min}$

In the 1299 nozzle chart you will find the nozzle closest to the desired output at a suitable pressure – Orange nozzle at 6 bar has a capacity of 1.07 l/min.

We recommend that you double-check the nozzle output with a measuring jug (with clean water in the

sprayer). You can do this by disconnecting the blower and directing the water into the jug, using a hose. If exactly 1 l/min is desired, the pressure can be adjusted with the pressure adjustment formula:

$$\left(\frac{\text{new output (l/min)}}{\text{known output (l/min)}} \right)^2 \times \text{known pressure (bar)} = \text{new pressure (bar)}$$

Example
 $\left(\frac{1.00 \text{ l/min}}{1.07 \text{ l/min}} \right)^2 \times 6 \text{ bar} = 5.24 \text{ bar}$

(B) Nozzle calibration when nozzle output must be adapted to the crop.

The drawing shows 8 nozzles pointing to each side. We can use the same example as in (A), with a row spacing of 5 metres, forward speed of 4 km/h and desired application rate of 600 l/ha.

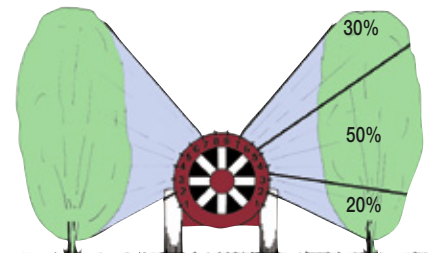

In this case nozzles 1 and 8 are shut off
2 and 3 apply 20 % = 4 l/min (each nozzle applies 1 l/min)
4 and 5 apply 50 % = 10 l/min (each nozzle applies 2.5 l/min)
6 and 7 apply 30 % = 6 l/min (each nozzle applies 1.5 l/min)

Chosen from the flow table on page 18 giving the following combination at 6 bar:

Nozzle 2 and 3: 1299-14 orange (1.07 l/min)
Nozzle 4 and 5: 1299-20 blue (2.68 l/min)
Nozzle 6 and 7: 1299-16 red (1.51 l/min)
This yields a total of 21.08 l/min. The pressure needs to be adjusted according to the pressure adjustment formula to get the correct volume of 20 l/min. A pressure of 5.4 bar is chosen.

$$\left(\frac{20.00 \text{ l/min}}{21.08 \text{ l/min}} \right)^2 \times 6 \text{ bar} = 5.4 \text{ bar}$$

Use the HARDI calibration disk (order No: 284554) for easy nozzle selection and calibration (see "Mistblower technique" for further information).

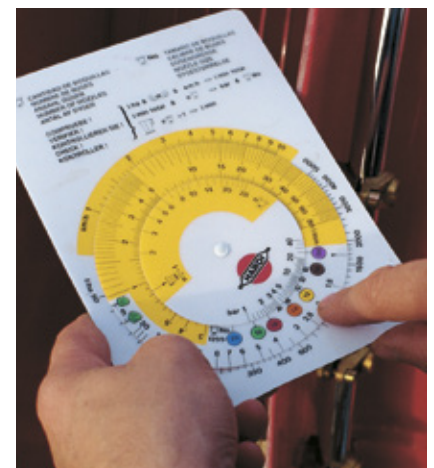

HARDI 1299 Hollow cone nozzles



These nozzles are superior in fine droplet delivery for optimal coverage of plant protection compounds. The high durability of the ceramic material makes this nozzle extensively used in orchard / mistblower applications at high working pressure or when applying abrasive materials.

- High efficiency nozzles
- Best choice for orchard applications
- Flow rates from 0.21 – 4.24 (at 3 – 15 bar)
- Working pressure from 3 to 25 bar
- CERAMIC – superior durability at high working pressure

Useful on droplegs for under leaf spraying where turbulence is required for good coverage. Also used on hand-held sprayers for insecticide and fungicide application and for band spraying.

bar		l/min
1299-06 White 371507		
3.0	VF	0.21
5.0	VF	0.27
6.0	VF	0.30
8.0	VF	0.34
10.0	VF	0.38
15.0	VF	0.47

bar		l/min
1299-12 Yellow 371510		
3.0	F	0.57
5.0	VF	0.74
6.0	VF	0.81
8.0	VF	0.94
10.0	VF	1.05
15.0	VF	1.28

bar		l/min
1299-17 Grey 371972		
3.0	F	1.16
5.0	F	1.50
6.0	F	1.64
8.0	F	1.90
10.0	VF	2.12
15.0	VF	2.60

bar		l/min
1299-08 Lilac 371508		
3.0	VF	0.29
5.0	VF	0.37
6.0	VF	0.41
8.0	VF	0.47
10.0	VF	0.52
15.0	VF	0.64

bar		l/min
1299-14 Orange 371511		
3.0	F	0.76
5.0	VF	0.98
6.0	VF	1.07
8.0	VF	1.24
10.0	VF	1.39
15.0	VF	1.70

bar		l/min
1299-18 Green 371513		
3.0	F	1.37
5.0	F	1.77
6.0	F	1.94
8.0	F	2.24
10.0	VF	2.50
15.0	VF	3.07

bar		l/min
1299-10 Brown 371509		
3.0	VF	0.37
5.0	VF	0.48
6.0	VF	0.53
8.0	VF	0.61
10.0	VF	0.68
15.0	VF	0.83

bar		l/min
1299-16 Red 371512		
3.0	F	1.08
5.0	F	1.39
6.0	F	1.52
8.0	VF	1.76
10.0	VF	1.97
15.0	VF	2.41

bar		l/min
1299-19 Black 371973		
3.0	F	1.55
5.0	F	2.00
6.0	F	2.19
8.0	F	2.53
10.0	F	2.83
15.0	VF	3.46

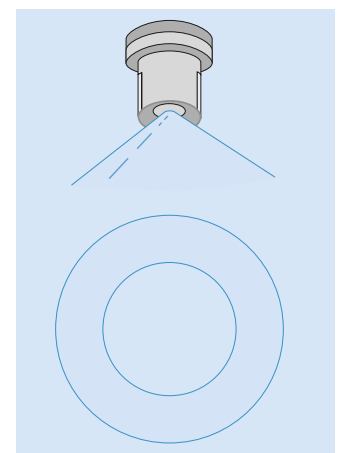

bar		l/min
1299-20 Blue 371514		
3.0	M	1.90
5.0	M	2.45
6.0	F	2.68
8.0	F	3.10
10.0	F	3.46
15.0	F	4.24

= Spray quality:
■ Very fine (VF), ■ Fine (F), ■ Medium (M), ■ Coarse (C), ■ Very Coarse (VC).

1099 Solid stream nozzles - CERAMIC

This nozzle disperses the spray liquid in a concentrated stream. Its main use is calibration of flows, often in connection with other nozzle components.

The capacity can be changed by placing the nozzle with or against the direction of flow.

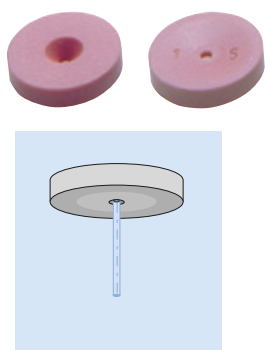

1099 bar	1099-8		1099-10		1099-12		1099-15		1099-18		1099-20		1099-23		1099-30	
	l/min															
2.0	0.54	0.43	0.91	0.65	1.14	0.94	1.88	1.42	2.54	1.98	3.09	2.46	3.98	3.18	6.43	5.18
5.0	0.83	0.68	1.38	1.01	1.78	1.47	2.89	2.23	4.03	3.13	4.86	3.92	6.40	5.03	10.47	8.45
8.0	1.04	0.86	1.71	1.28	2.25	1.86	3.59	2.82	5.10	3.96	6.13	4.98	8.17	6.37	13.44	10.86
10.0	1.15	0.95	1.89	1.42	2.51	2.07	3.99	3.15	5.70	4.43	6.85	5.58	9.17	7.12	15.13	12.23
15.0	1.39	1.16	2.27	1.74	3.06	2.53	4.82	3.85	6.98	5.42	8.37	6.87	11.31	8.72	18.77	15.19
20.0	1.59	1.34	2.59	2.00	3.52	2.92	5.51	4.44	8.06	6.26	9.65	7.95	13.13	10.07	21.87	17.71
30.0	1.92	1.63	3.11	2.44	4.30	3.56	6.65	5.43	9.88	7.67	11.80	9.78	16.20	12.33	27.13	21.99
50.0	2.43	2.09	3.91	3.13	5.52	4.58	8.44	6.99	12.76	9.90	15.20	12.68	21.12	15.92	35.59	28.89
No	371309		371310		371311		371312		371313		371314		371315		371884	

1553 cone nozzles

HARDI 1553 Cone nozzles are used with one of the four available swirl plates for hollow cone and full cone spraying. The hollow cone nozzle can be used for pesticide application on boom sprayers, mistblowers or knapsack sprayers. The HARDI 1553 cone nozzle can also be used without swirl plates for solid stream application (see page 16).

Drop sizes

The difference between the 4 swirl plates is the droplet size. The blue swirl plate has a very fine droplet spectrum, the grey a fine droplet spectrum and the black swirl plate a medium droplet spectrum. The white swirl plate has a medium droplet spectrum and is giving a full cone spray.



Large drop adaptor

A large drop adaptor (371077) is available for the grey swirl plate.



This adaptor changes the droplet spectrum to very large droplets.



1553	-8	-10	-12	-14	-16	-18	-20	-22	-24	-30	-35	-40
bar	l/min											
2.0	0.20	0.25	0.31	0.36	0.44	0.49	0.54	0.57	0.61	0.72	0.80	0.85
3.0	0.24	0.31	0.38	0.44	0.54	0.60	0.66	0.70	0.75	0.88	0.98	1.04
5.0	0.32	0.40	0.49	0.57	0.70	0.77	0.85	0.90	0.96	1.14	1.26	1.34
6.0	0.35	0.43	0.54	0.62	0.76	0.85	0.94	0.99	1.06	1.25	1.39	1.47
8.0	0.40	0.50	0.62	0.72	0.88	0.98	1.08	1.14	1.22	1.44	1.60	1.70
10.0	0.45	0.56	0.69	0.80	0.98	1.10	1.21	1.27	1.36	1.61	1.79	1.90
15.0	0.55	0.68	0.85	0.99	1.20	1.34	1.48	1.56	1.67	1.97	2.19	2.33
20.0	0.64	0.80	0.98	1.14	1.40	1.54	1.70	1.80	1.92	2.28	2.52	2.68
25.0	0.71	0.88	1.10	1.27	1.56	1.73	1.91	2.02	2.16	2.55	2.83	3.01
No.	370016	370027	370031	370042	370053	370064	370075	370086	370097	370101	370112	370123
12 pcs.	750256	755031	755382	755064	755385	755065	755097	755066	755123	750257	755067	755068

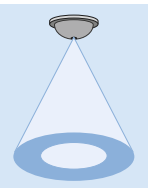
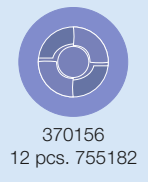

1553	-8	-10	-12	-14	-16	-18	-20	-22	-24	-30	-35	-40
bar	l/min											
2.0	0.40	0.52	0.67	0.85	1.04	1.17	1.34	1.43	1.60	1.88	2.15	2.35
3.0	0.49	0.64	0.82	1.04	1.27	1.43	1.64	1.75	1.96	2.30	2.63	2.88
5.0	0.63	0.82	1.06	1.34	1.64	1.85	2.12	2.26	2.53	2.97	3.40	3.72
6.0	0.69	0.90	1.16	1.47	1.80	2.03	2.32	2.48	2.77	3.26	3.72	4.07
8.0	0.80	1.04	1.34	1.70	2.08	2.34	2.68	2.86	3.20	3.76	4.30	4.70
10.0	0.89	1.16	1.50	1.90	2.33	2.62	3.00	3.20	3.58	4.20	4.81	5.25
15.0	1.10	1.42	1.83	2.33	2.85	3.20	3.67	3.92	4.38	5.15	5.89	6.44
20.0	1.26	1.64	2.12	2.68	3.28	3.70	4.24	4.52	5.06	5.94	6.80	7.44
25.0	1.41	1.84	2.37	3.01	3.68	4.14	4.74	5.06	5.66	6.65	7.60	8.31
No.	370016	370027	370031	370042	370053	370064	370075	370086	370097	370101	370112	370123
12 pcs.	750256	755031	755382	755064	755385	755065	755097	755066	755123	750257	755067	755068

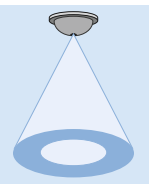
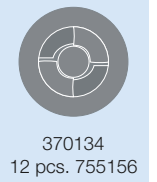

1553	-8	-10	-12	-14	-16	-18	-20	-22	-24	-30	-35	-40
bar	l/min											
2.0	0.41	0.55	0.72	0.92	1.15	1.28	1.54	1.68	1.90	2.26	2.65	3.10
3.0	0.50	0.67	0.88	1.13	1.41	1.57	1.89	2.06	2.33	2.77	3.25	3.80
5.0	0.65	0.87	1.14	1.45	1.82	2.02	2.43	2.66	3.00	3.57	4.19	4.90
6.0	0.71	0.95	1.25	1.59	1.99	2.22	2.67	2.91	3.29	3.91	4.59	5.37
8.0	0.82	1.10	1.44	1.84	2.30	2.56	3.08	3.36	3.80	4.52	5.30	6.20
10.0	0.92	1.23	1.61	2.06	2.57	2.86	3.44	3.76	4.25	5.05	5.93	6.93
15.0	1.12	1.51	1.97	2.52	3.15	3.51	4.22	4.60	5.20	6.19	7.26	8.49
20.0	1.30	1.74	2.28	2.90	3.64	4.04	4.86	5.32	6.00	7.14	8.38	9.80
25.0	1.45	1.94	2.55	3.25	4.07	4.53	5.44	5.94	6.72	7.99	9.37	10.96
No.	370016	370027	370031	370042	370053	370064	370075	370086	370097	370101	370112	370123
12 pcs.	750256	755031	755382	755064	755385	755065	755097	755066	755123	750257	755067	755068

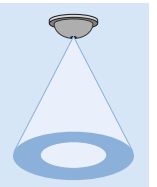
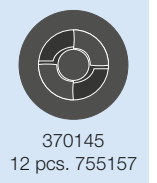

1553	-8	-10	-12	-14	-16	-18	-20	-22	-24	-30
bar	l/min									
2.0	0.41	0.60	0.89	1.24	1.56	2.16	2.33	2.58	2.90	3.45
3.0	0.50	0.73	1.09	1.52	1.91	2.65	2.85	3.16	3.55	4.23
4.0	0.58	0.84	1.26	1.78	2.20	3.06	3.30	3.64	4.10	4.88
5.0	0.65	0.95	1.41	1.96	2.47	3.42	3.68	4.08	4.59	5.45
6.0	0.71	1.04	1.54	2.15	2.70	3.74	4.04	4.47	5.02	5.98
8.0	0.82	1.20	1.78	2.48	3.12	4.32	4.66	5.16	5.80	6.90
10.0	0.92	1.34	1.99	2.77	3.49	4.83	5.21	5.77	6.48	7.71
12.0	1.00	1.46	2.18	3.04	3.82	5.30	5.70	6.32	7.10	8.46
15.0	1.12	1.64	2.44	3.40	4.27	5.92	6.38	7.07	7.94	9.45
No.	370016	370027	370031	370042	370053	370064	370075	370086	370097	370101
12 pcs.	750256	755031	755382	755064	755385	755065	755097	755066	755123	750257

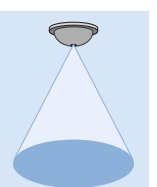
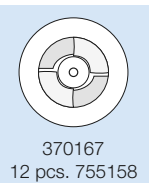

Calibration of hand operated sprayers

To ensure precise and safe applications in the field, effective calibration is essential. Calibration must always be done with clean water and before the use of any crop protection product. Follow this guide to calibrate your hand sprayer.

- 1** Add clean water to the clean sprayer.



- 2** Check that sprayer operates correctly and safely.



- 3** Use correct nozzle height and measure swath width.



- 4** Practise spraying at comfortable walking speed and with correct nozzle height.



- 5** Fill up with clean water.



- 6** Spray 100 m² (100 square metres).

Swath width m	Spraying distance m
0.5	200
0.7	143
1.0	100
1.2	83
1.5	67

- 7** To find application rate (litres/ha), multiply the amount of spray missing in the tank by 100. (Measure when refilling).



Example:

100 m² = 1/100 ha.
If 3 litres were used to spray 100 m², you are applying:
3 x 100 = 300 l/ha.

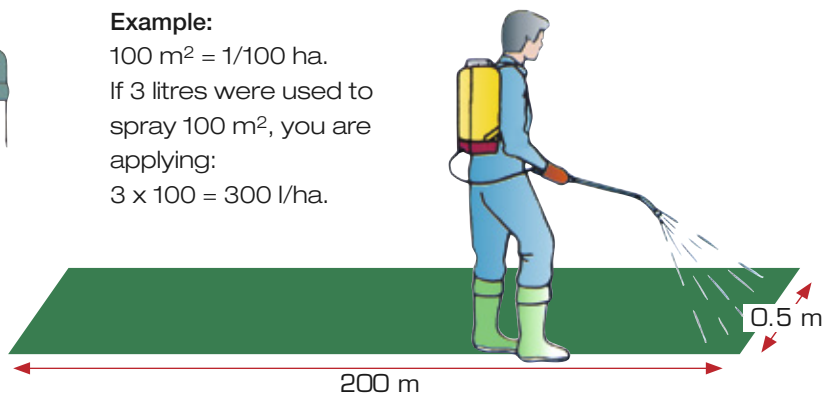

Nozzles for hand operated sprayers

HC - Hollow cone nozzles - SYNTAL



- Very wide spray angle
- One piece construction
- SYNTAL



	Yellow	Grey
bar	l/min	
1.0	0.46	1.39
1.5	0.57	1.70
2.0	0.65	1.96
2.5	0.73	2.19
3.0	0.80	2.40
4.0	0.92	2.77
no.	371694	371696

This nozzle is designed for knapsack sprayers. The restrictor and the nozzles are clicked together to avoid losing parts when taken apart for cleaning.

HARDI REFLEX nozzles - SYNTAL



- Spray width from 0.5 to 2 m
- Even distribution across the swath
- 200 l/ha at 1 bar

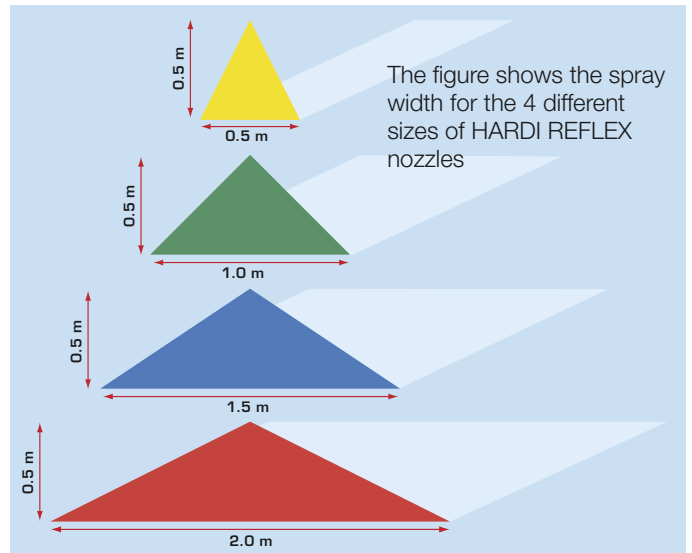
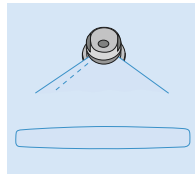

These nozzles are designed so the application volume is the same for all sizes at 1 bar and a normal walking speed (1 m/s), only the spray width changes.



	Yellow	Green	Blue	Red
bar	l/min			
1.0	0.60	1.20	1.80	2.40
no.	372020	372021	372022	372023

Adjustable nozzles - SYNTAL



- Adjustable by turning the tip
- From solid stream to hollow cone
- Available with M18 thread

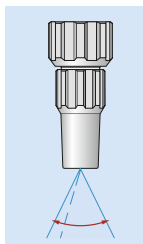

These nozzles can be used on knapsack sprayers or spray guns, where you want to change the characteristics of the spray cone, and the demands for precision is less important.

No. 755835			
bar	l/min		Spray angle
1.5	0.69	1.25	80°
2.0	0.71	1.40	85°
3.0	0.88	1.65	90°
4.0	0.95	1.85	90°
5.0	1.10	2.18	95°



In many crops, band spraying provides an efficient way of reducing chemical consumption. HARDI produces both conventional and air assisted special sprayers for row crops.

Calibration for band spraying

1 Forward speed

See page 8 – calibration of field sprayers

2 l/ha in band

Label recommendations usually state total l/ha rates, also called broadcast rates. When band spraying we only want to apply this broadcast rate in the bands, so instead we will here call it: **l/ha in band**.

3 Calculation of nozzle capacity

$$\frac{\text{l/ha in band} \times \text{band width (m)} \times \text{km/h}}{600} = \text{l/min per band}$$

If 200 l/ha are to be applied at 6 km/h in a 0.2 m wide band, the necessary output will be: 0.4 l/min/ per band. If, for instance, 1 nozzle per band is used, every nozzle should apply 0.4 l/min. Nozzles and pressures can then be found in the relevant tables.

4 Calculation of total required volume of spray mix

$$\frac{\text{area of field (ha)} \times \text{l/ha in band} \times \text{band width (m)}}{\text{row spacing (m)}} = \text{spray mix (total l/field)}$$

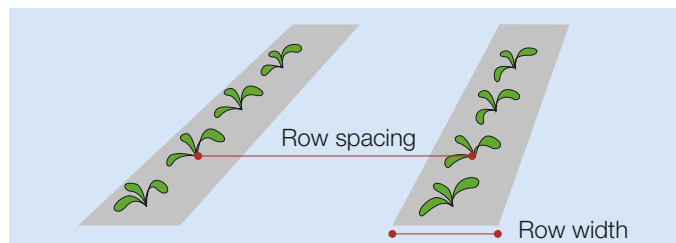

If the row spacing is 0.5 m; band width 0.2 m; field 5 ha; and l/ha in band = 200 l/ha – the total required volume will be:

$$\frac{5 \times 200 \times 0.2}{0.5} = 400 \text{ l}$$

5 Calculation of amount of chemical per tank

$$\frac{\text{litres of water in tank} \times \text{chemical dose desired (l/ha)}}{\text{l/ha in band}} = \text{litres of chemical per tank}$$

If the tank holds 400 l, and 2 l of chemical products are required per ha when 200 l/ha in band is applied, the following calculation should be used:

$$\frac{400 \times 2}{200} = 4 \text{ l chemical product per tank}$$

HARDI Even spray nozzles

HARDI 4680E 80° Even spray nozzles - SYNTAL



- Even distribution is ideal for band spraying
- Use the 4680E on hand operated sprayers, when only one nozzle is used
- Application range: 0.22 – 3.98 l/min
- Pressure range 1.5 – 5 bar

Because of the even spray distribution from this nozzle, it is especially well suited for row and inter-row spraying. It is used on hand operated sprayers or on a spray boom where chemicals need to be applied over a narrow area.

4680E	-7E	-9E	-11E	-13E	-15E	-21E	-25E	-27E	-37E
bar	l/min								
1.5	0.22	0.30	0.43	0.61	0.82	1.23	1.52	1.86	3.03
2.0	0.25	0.35	0.50	0.70	0.95	1.42	1.75	2.15	3.50
2.5	0.28	0.39	0.56	0.78	1.06	1.59	1.94	2.39	3.89
3.0	0.31	0.43	0.61	0.86	1.16	1.74	2.14	2.63	4.29
4.0	0.35	0.49	0.71	0.99	1.34	2.01	2.47	3.04	4.95
5.0	0.40	0.55	0.79	1.11	1.50	2.25	2.77	3.40	5.53
No.	371576	371577	371578	371579	371580	371581	371582	371583	371585

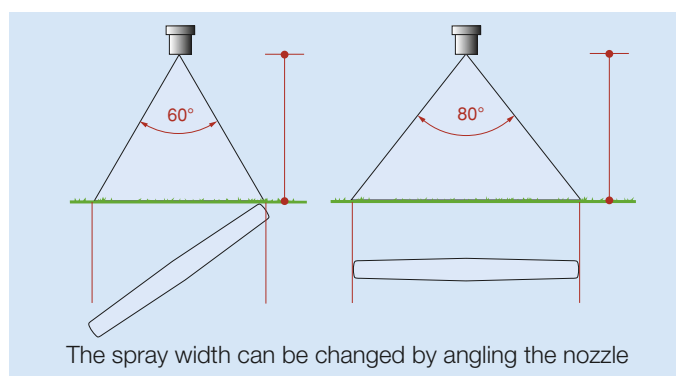

End nozzles

Off-centre SYNTAL spray nozzle. These nozzle types give an asymmetric spray pattern and disperse the product at a certain distance from the nozzle. If fitted to the end of a boom, they give extra spray width. They are ideal for applications such as fence line spraying. These nozzles can also be fitted on the frame of the spray tank when not using a boom for under tree spraying in vineyards and orchards.

1850 End nozzles 3/8" – SYNTAL



- Off-centre spray nozzle
- 3/8"
- Pressure range: 1 to 6 bar
- Spray width up to 3.5 m
- SYNTAL precision moulded thermoplastic

This nozzle is mounted on the end of the boom tube using the 730076 mounting kit.

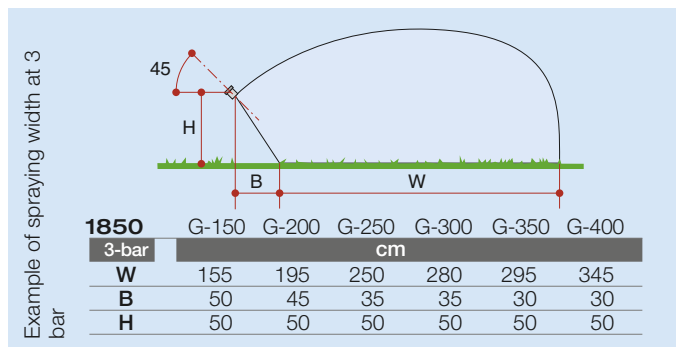

1740 End nozzles 1/2" – SYNTAL



- Off-centre spray nozzle
- 1/2"
- Pressure range: 1 to 6 bar
- Spray width up to 5.2 m
- SYNTAL precision moulded thermoplastic

This nozzle is mounted on the end of the boom tube using the 72023300 mounting kit.

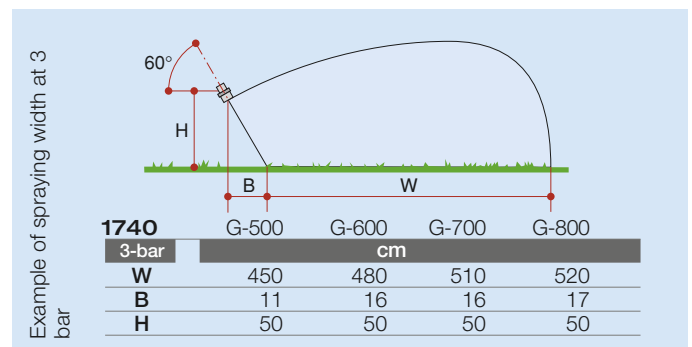

1850	G-150	G-200	G-250	G-300	G-350	G-400
bar	l/min					
2.0	0.83	1.36	2.36	2.95	4.50	6.20
3.0	1.02	1.67	2.89	3.61	5.51	7.59
4.0	1.18	1.92	3.34	4.18	6.36	8.76
5.0	1.31	2.15	3.73	4.66	7.12	9.80
6.0	1.44	2.36	4.09	5.11	7.79	10.74
No.	370366	370377	370381	370392	370403	370414

1740	G-500	G-600	G-700	G-800
bar	l/min			
2.0	7.80	9.00	10.60	12.40
3.0	9.55	11.02	12.98	15.19
4.0	11.04	12.72	15.00	17.54
5.0	12.33	14.23	16.76	19.61
6.0	13.51	15.59	18.36	21.48
No.	370425	370436	370447	370451

G - Giant end nozzles – SYNTAL



- Off-centre spray nozzle
- Pressure range: 1.5 to 5 bar
- Spray width up to 8 m
- SYNTAL precision moulded thermoplastic

This nozzle is mounted on the end of the boom using a special mounting kit – ask your HARDI dealer.

bar	G-1200 White	G-1600 Blue
	l/min	
1.5	14.80	19.80
2.0	17.20	22.90
3.0	21.00	28.00
4.0	24.30	32.40
5.0	27.00	36.00
No.	371557	371558

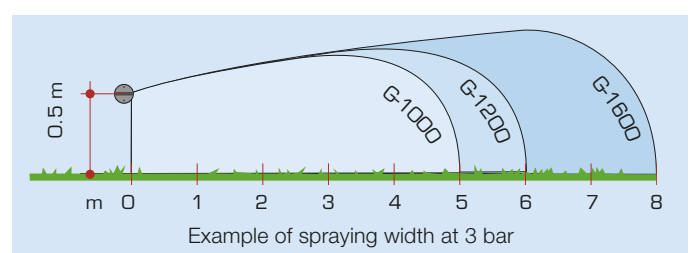

HARDI can supply a range of nozzles for special applications such as tank and container cleaning. If you do not find what you need in this product guide, please contact your HARDI dealer.

4665 65°

Flat spray nozzles - SYNTAL



- Recommended pressure range: 1.5 to 5 bar
- Recommended boom height above target: 70 to 80 cm.
- SYNTAL



This nozzle provides an elliptical spray pattern (FlatFan) with a 65° angle. A uniform distribution is obtained, with correct overlap between spray patterns from adjacent nozzles.

This nozzle has additional applications for industrial purposes.

4665	4665-10	4665-12	4665-14	4665-16	4665-20	4665-24	4665-30
bar	l/min						
1.5	0.33	0.48	0.64	0.84	1.11	1.47	2.08
2.0	0.38	0.55	0.74	0.97	1.28	1.70	2.40
3.0	0.47	0.67	0.91	1.19	1.57	2.08	2.94
4.0	0.54	0.78	1.04	1.38	1.82	2.40	3.40
5.0	0.60	0.87	1.17	1.53	2.02	2.69	3.79
10.0	0.85	1.23	1.65	2.17	2.86	3.80	5.37
No.	370285	370296	370307	370311	370322	370333	370344

4625 25°

Flat spray nozzles - SYNTAL



- Pressure range: 2 to 25 bar
- SYNTAL

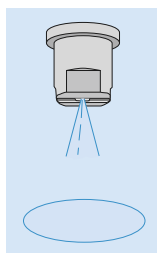

This nozzle provides an elliptical spray pattern (flat fan) with a 25° angle. The narrow spray angle results in a high impact spray, which is well suited for cleaning as well as for spraying trees and bushes, where a long range is very useful.

4625	4625-20	4625-24	4625-30	4625-36	4625-46	4625-54
bar	l/min					
2.0	1.50	2.00	2.60	3.90	5.50	6.20
4.0	2.12	2.82	3.68	5.25	7.78	8.76
6.0	2.60	3.46	4.50	6.75	9.53	10.74
10.0	3.35	4.47	5.81	8.72	12.30	13.86
25.0	5.307.07	9.19	13.79	19.45	21.92	
No.	370506	370517	370521	370532	370543	370554

5131

Misting nozzles - SYNTAL



- Pressure range: 2 to 5 bar
- Hollow Cone nozzle
- Very Fine droplets
- SYNTAL

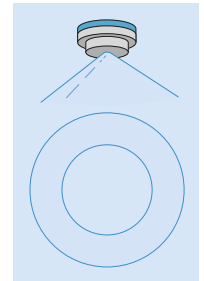

This nozzle consists of a synthetic tip and a blue swirl plate (370156).

The droplet spectrum is very fine.

The low capacity and extremely fine atomization make this nozzle useful for special purposes such as adjustment of air temperature and humidity in hot climates.

5131	5131
bar	l/min
2.0	0.20
3.0	0.25
4.0	0.28
5.0	0.32
No.	370963

3600

Deflector spray nozzles - SYNTAL



- Pressure range: 1 to 10 bar
- SYNTAL

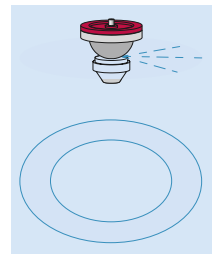

Deflector spray nozzle of synthetic material. This nozzle type produces a round spray pattern (360°).

The speed of the droplets is low, producing a slowly dispersing cloud. The atomization and dispersion are optimal between 1 to 5 bar. Useful for raising humidity in greenhouses etc.

3600	3600-30	3600-35	3600-40
bar	l/min		
1	1.34	1.63	1.98
1.5	1.65	1.99	2.42
2.0	1.90	2.30	2.80
3.0	2.33	2.82	3.43
4.0	2.68	3.26	3.96
5.0	3.00	3.64	4.43
6.0	3.29	3.98	4.85
8.0	3.80	4.60	5.60
10.0	4.25	5.14	6.26
No.	703054	703065	703076

Container rinsing nozzles - SYNTAL



- Multi hole rinsing nozzle
- 40 solid streams
- Pressure range: 1.5 to 5 bar
- SYNTAL



- Rotary rinsing nozzle
- Rotary spray swaths
- Pointed top for easy foil opening
- SYNTAL

These nozzles are mainly used for washing out residues in chemical containers and bags. Can also be used for some irrigation purposes. Tests have shown that the most efficient way of cleaning chemical containers is by using these rinsing nozzles.

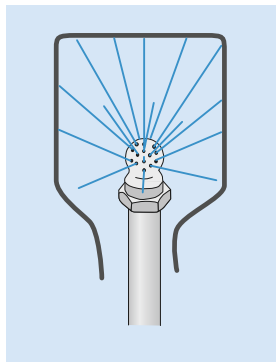

	Multi hole	Rotary
bar	l/min	
1.5	14.2	-
2.0	16.4	-
3.0	20.1	-
4.0	23.2	-
5.0	25.9	-
No.	371552	72317300

5066 Agitation nozzles - SYNTAL



- Pressure range: 1 to 15 bar
- SYNTAL

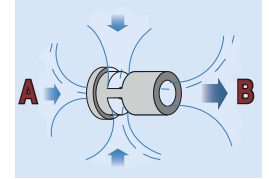

This nozzle type is used for tank agitation. The venturi effect of the nozzle increases the agitation B several times in relation to the liquid passing through the calibrated part of the nozzle A.

Useful for a fast and continuous mixing of for example pesticides in suspension.

5066	5066-1.5		5066-2.0		5066-2.5		5066-3.0	
bar	l/min							
	A	B	A	B	A	B	A	B
1	1.20	7.35	1.84	9.12	3.04	11.74	5.09	15.13
1.5	1.47	9.01	2.25	11.17	3.72	14.38	6.24	18.53
2.0	1.70	10.40	2.60	12.90	4.30	16.60	7.20	21.40
3.0	2.08	12.74	3.18	15.80	5.27	20.33	8.82	26.21
5.0	2.69	16.44	4.11	20.40	6.80	26.25	11.38	33.84
6.0	2.94	18.01	4.50	22.34	7.45	28.75	12.47	37.07
10.0	3.80	23.26	5.81	28.85	9.62	37.12	16.10	47.85
15.0	4.66	28.48	7.12	35.33	11.78	45.46	19.72	58.61
No.	370462		370473		370484		370495	

Tank cleaning nozzles



- Rotating nozzle for tank cleaning
- 8 solid streams at high velocity
- SYNTAL

This nozzle is made for cleaning the insides of sprayer tanks. The different angle of the 8 solid streams ensures a excellent rinsing of the entire inside surface of the sprayer tank.

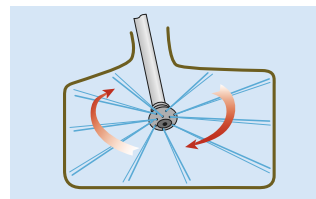

Tank cleaning nozzle	
bar	l/min
5	83
10	117
No.	728014

HARDI recommends the use of a cleaning agent to ensure sufficient cleaning of the tank.

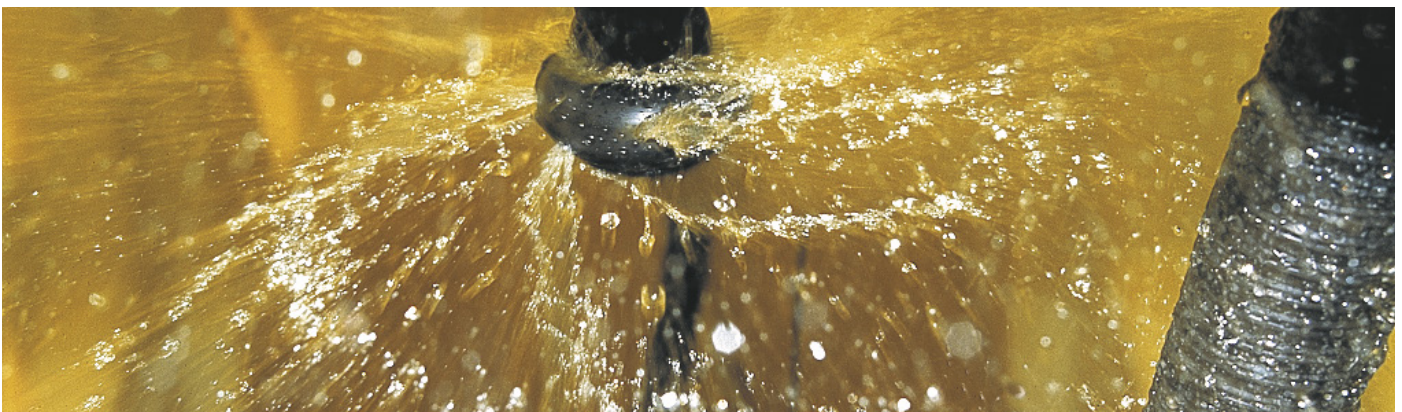

HARDI nozzles on all liquid systems

HARDI ISO nozzles fulfil ISO (International Standards Organization) standards regarding flow, numbers, colours and outer dimensions. This ensures that it is easy to fit HARDI ISO nozzles on all sprayer brands. You can see below the fittings, which allow you to adapt HARDI ISO nozzles to your sprayer.

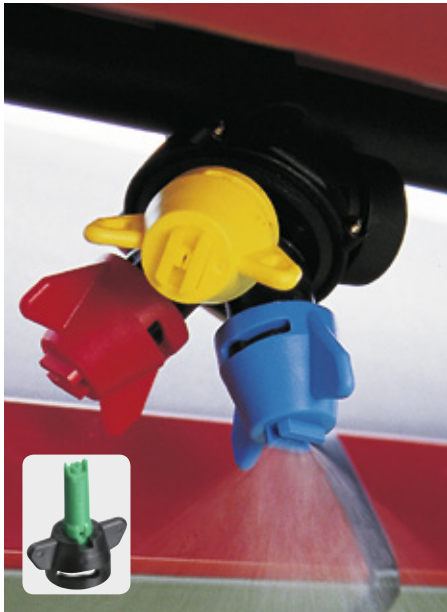

On sprayers with HARDI SNAP-FIT systems, the HARDI COLOR TIPS (CT) are recommended for safe and easy handling. For INJET and MINIDRIIFT nozzles use the 334083 black nozzle cap.



On sprayers with TeeJet or compatible systems use Single nozzles (S) and the 334862 black cap. The same cap is used for INJET and MINIDRIIFT nozzles. (gasket: 242222).



On all other systems use the ISO cap delivered with your sprayer together with Single nozzles (S) or INJET (INJET require a special 10 mm cap).

Conversion table for HARDI ISO nozzles

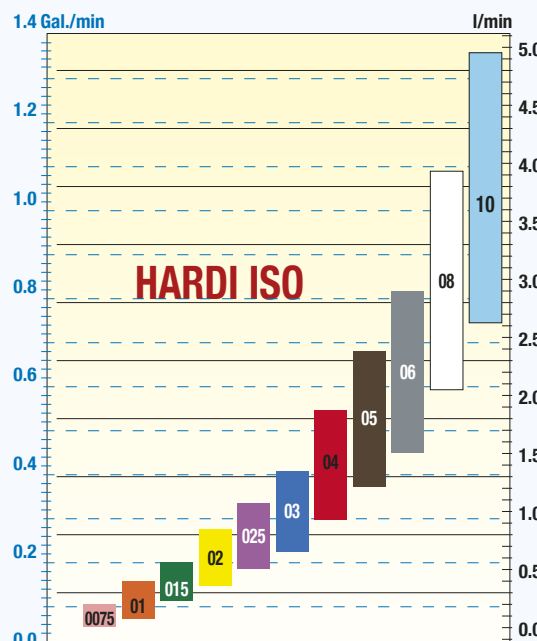

Flows at pressure from 1.5 to 5 bar (20 to 70 PSI)

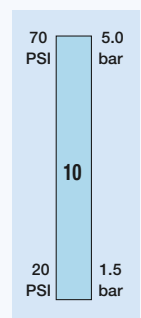

Filters

The HARDI filter range ensures optimal filtration of spray liquid on its way from the tank to the nozzles. The filtration system is a 4-step process:

Filter size Mesh (*standard)	80	50	*30
	100	*80	(50)
	100	80	*50
	100	*80	(50)

- 1** Top mounted suction or EasyClean filter with a standard size of 30 mesh.
- 2** Self-cleaning or ClyoneFilter. In this filter a by-pass system ensures that the filter screen is always clean. The standard size is 80 mesh.
- 3** In-line filters. These filters reduce nozzle filter blockages and make filter cleaning quicker.
- 4** Nozzle filters. These filters make sure that particles that would block the nozzles are captured. With these the total filtration process is completed.

Available in 50, 80 and 100 mesh.

It is essential that the filters are chosen according to the nozzles used.

Flat spray nozzle size
from 0075 to 02
from 025 to 03
04 or bigger

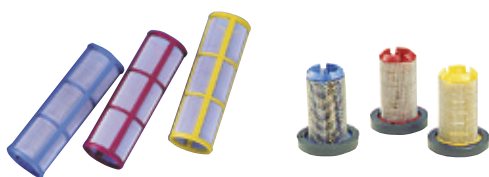

Mesh

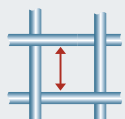

	30	50	80	100
mm	0.58	0.30	0.18	0.15

Fittings

TRIPLET provides ease of switching between different nozzle types and sizes.

Order No:
725078



For mounting special nozzles such as the large drop flat spray nozzle and hollow cone nozzles, use the 322068 adaptor piece together with 3/8" union nuts.



1 ISO and INJET nozzles use the white 3/8" union nut (321517)

2 Black HARDI SNAP-FIT cap (334083)

3 Black TeeJet cap, (334862) (gasket: 242222)



In-line filter complete with housing etc. - ready to fit!

Hose	Mesh		
	50	80	100
1/2"	845205	845206	845207
3/4"	845208	845209	845210



Mesh	No.					
	1 pcs	1 pcs	1 pcs	1 pcs	12 pcs	12 pcs
30	72278800	615415	-	-	-	-
50	72278900	615416	635681	615443	750229	755410
80	72279000	615417	635397	615444	750228	755215
100	-	-	635677	615445	750234	755411



www.hardi-nozzles.com



#HARDIsprayers

HIA-MARKETING GB-897085-07-2017



HARDI INTERNATIONAL A/S

Herthadalvej 10 · 4840 Nørre Alslev
Tlf.: +45 43 58 85 00 · Fax: +45 43 58 85 20
E-mail: hardi@hardi-international.com
www.hardi-international.com

HARDI AUSTRALIA Pty. Ltd.

534-538 Cross Keys Road, Cavan · South Australia, 5094
Phone: QLD(07)3375 3544 · NSW(02)96274555,
VIC(03)9310 2211 · SA(08)8343 9933 · WA(08)9353 2088
Email: info@hardi-aus.com · www.hardi.com.au